

ALPHADISC™ CLD

Smartphone Operated Controller
for Filtration Systems

/ Installation, Operation and Maintenance
Instructions

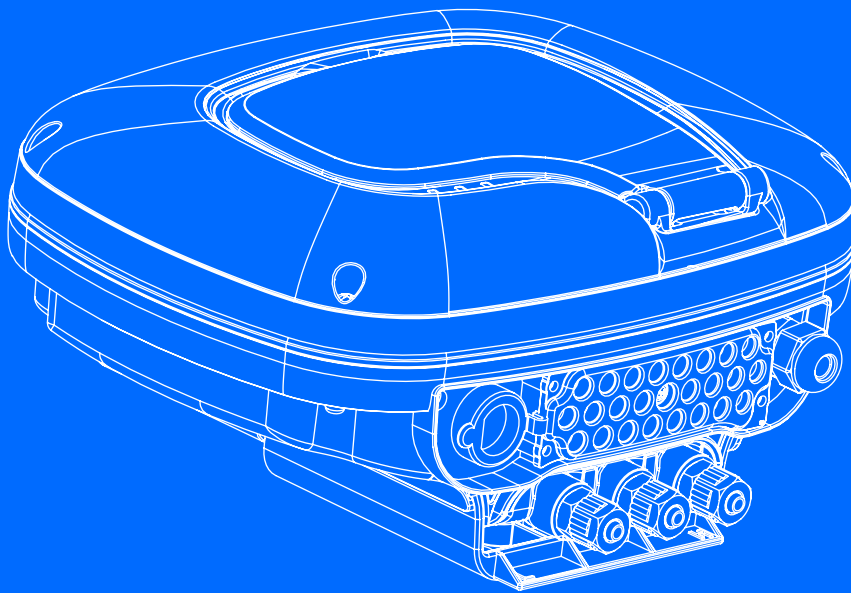

Patent Pending

CE

2021
v2.0

 **NETAFIM™**
GROW MORE WITH LESS

Contents

1. Safety Instructions.....	8
1.1 General	8
1.2 Installation.....	8
1.3 Commissioning	9
1.4 Operation and Control	9
1.5 Before Any Maintenance or Non-standard Operation	9
1.6 Preventing Damage Due to Frost.....	9
2. Introduction.....	10
2.1 About the AlphaDisc™ CLD Controller	10
2.2 The AlphaDisc™ CLD Controller Components.....	10
3. AlphaDisc™ CLD Controller Installation	11
3.1 Installation on a Pole.....	12
3.2 Installation on a Wall.....	12
3.3 AlphaDisc™ CLD Terminal Blocks Connections	13
3.4 AlphaDisc™ CLD DP Sensor Connections	15
3.5 Batteries Installation/Replacement.....	16
4. AlphaDisc™ CLD Desktop, AlphaDisc™ CLD Mobile, and AlphaDisc™ BLE Mobile Applications	18
4.1 Applications Preparation	18
4.2 Adding AlphaDisc™ CLD Controller to a User Account	25
4.3 Getting to Know the AlphaDisc™ CLD Desktop Application	37
4.4 Getting to know the AlphaDisc™ CLD Mobile Application...	49
4.5 Getting to know the AlphaDisc™ BLE Mobile Application ...	58

5. AlphaDisc™ CLD Controller Operation.....	62
5.1 AlphaDisc™ CLD Controller Buttons	62
5.2 AlphaDisc™ CLD Controller Sharing	62
5.3 AlphaDisc™ CLD Controller Parameters Setting	65
5.4 AlphaDisc™ CLD Controller Parameters Restoration	68
5.5 AlphaDisc™ CLD Controller Counters Reset	71
5.6 Manual Flushing.....	73
5.7 Downloading Reports.....	75
5.8 Chaining AlphaDisc™ CLD Controllers	76
6. Appendix A. AlphaDisc™ CLD Controller Settings.....	77
6.1 The Basic Settings	77
6.2 Technician Settings	78
7. Appendix B. Alarms and Faults List.....	81
8. Netafim Limited Warranty	82

Products appearing in this catalog may be covered by one or more of the following US Patent Nos. 7644735, 7410108 and other U.S. patents pending or corresponding issued or pending foreign patents. All rights are reserved. You are specifically prohibited and not allowed to reproduce, copy, duplicate, manufacture, supply, sell, hire, distribute or adapt all or any part of this publication including any packaging. Netafim™, are trademarks of Netafim™ Ltd., registered in the U.S. and other countries. We endeavor to provide accurate, quality and detailed information. However we cannot accept liability for your reliance on the provided information and you are advised to independently seek professional advice from Netafim™ and/ or its authorized representatives. There is no undertaking by us that the provided information or any part thereof is accurate, complete or up to date. Mention of third-party products is for informational purposes only and constitutes neither an endorsement nor a recommendation. Netafim™ assumes no responsibility with regard to the performance or use of these products. In no event shall Netafim™ be liable for any indirect, incidental, special or consequential damages.

1. Safety Instructions

1.1 GENERAL

- ✓ The manufacturer's filtration products always operate as components in a larger system. System designers, installers and operators must comply with all relevant safety standards.
- ✓ Prior to installation, operation, maintenance and/or any other type of action carried out on the controller, carefully read these installation and operation instructions.
- ✓ During installation, operation and/or maintenance of the controller all conventional safety instructions must be observed in order to avoid danger to the workers, the public and/or to property in the vicinity.
- ✓ The system is for use for non-hazardous liquids only!

NOTE

The filter controlled by the controller enters the flushing mode automatically without any prior warning.

- ✓ No change or modification to the equipment is permitted without written notification given by the manufacturer or by its representative(s) on the manufacturer's behalf.
- ✓ Always observe standard safety instructions and good engineering practices whilst working in the filter's vicinity.
- ✓ Use the controller only for its intended use as designed by the manufacturer only. Any misuse of the controller may lead to damage and may affect your warranty coverage. Consult with the manufacturer prior to any non-standard use of this equipment
- ✓ Do not carry out system cleaning and/or maintenance in an explosive atmosphere.

1.2 INSTALLATION

General

- ✓ Install the controller according to the detailed installation instructions provided in this manual or in the Quick Guide provided with the filter or controller.
- ✓ Make sure to leave enough side and top clearance to enable easy access for safe maintenance operations.
- ✓ Make sure to have suitable lighting at the filter's location to enable good visibility and safe maintenance.
- ✓ Arrange suitable platforms and safety barriers to enable easy and safe access to the controller without needing to climb on pipes and other equipment. Verify that any platform, barrier, ladder, or other such equipment is built, installed, and used in accordance with the relevant local authorized standards.
- ✓ Use only appropriate standard tools and equipment operated by qualified operators when installing, operating, and maintaining the controller.
- ✓ When installation is required in hazardous environment sites, underground or high above ground, make sure that the site design and the auxiliary equipment are appropriate and that installation procedures are carried out in accordance with the relevant standards and regulations.
- ✓ Make sure walking areas around the installation are slip resistant when wet.

Shipment and transporting

- ✓ Shipping and transporting the controller must be done in a safe and stable manner and in accordance with the relevant standards and regulations.

Electricity

- ✓ Electric wiring must be performed by an authorized electrician only, using standardized and approved components.
- ✓ The filter should be installed in a manner in which the controller's electrical components are protected from direct contact with water.
- ✓ When using external power, a 1A external fuse and minimum 22AWG wires are required.

1.3 COMMISSIONING

- ✓ Carefully read this manual prior to operating the controller.
- ✓ In order to achieve maximum performance and smooth operation of the controller, performing the start-up and first operation procedures exactly as described in this manual is crucial.

1.4 OPERATION AND CONTROL

- ✓ Do not operate the controller before carefully reading and becoming familiar with its operation instructions.
- ✓ Observe the safety stickers on the controller and do not perform any operation other than those given in this manual.
- ✓ Do not operate or use the controller for purposes other than its original design.
- ✓ The system is for use for non-hazardous liquids only!
- ✓ Do not carry out system cleaning and/or maintenance in an explosive atmosphere.

1.5 BEFORE ANY MAINTENANCE OR NON-STANDARD OPERATION

- ✓ Servicing the controller should be done only by technicians authorized by the manufacturer.
- ✓ Do not carry out system cleaning and/or maintenance in an explosive atmosphere.
- ✓ Disconnect the controller and the filter from the power supply and lock the main power switch.

1.6 PREVENTING DAMAGE DUE TO FROST

- ✓ Non-operating periods:
To avoid damage or breakage when temperatures drop, command tubes must be disconnected and drained prior to non-operating periods.
- ✓ Operating season:
Your AlphaDisc™ CLD controller is equipped with a built-in feature that detects low temperatures and increases the number of flushes to avoid freezing of water. You can activate and adjust the settings of this feature in your Settings menu.

2. Introduction

2.1 ABOUT THE ALPHADISC™ CLD CONTROLLER

AlphaDisc™ CLD by Netafim, is our most advanced smart controller for a wide range of filtration solutions. By using the AlphaDisc™ CLD, you will be able to receive real time data regarding your filter performance, relevant alerts, technical and marketing updates. AlphaDisc™ CLD allows you to modify various parameters for your filtration system remotely.

Supporting both cloud and Bluetooth® wireless technology, AlphaDisc™ CLD allows you to connect to your filter from any mobile device or desktop, regardless of your location (while on the Cloud).

2.2 THE ALPHADISC™ CLD CONTROLLER COMPONENTS

Take a few moments to familiarize yourself with the AlphaDisc™ CLD Controller components:



- | | | |
|-------------------------|---|------------------------------------|
| 1. Protection cover | 5. Water connection for internal DP sensor (inlet and outlet) | 8. External antenna SMA connection |
| 2. LCD display | 6. Power cable gland | |
| 3. Left control button | 7. RJ-45 connection (optional) | |
| 4. Right control button | | |

3. AlphaDisc™ CLD Controller Installation

The AlphaDisc™ CLD controller can be supplied as part of a filtration system or as a standalone device. The controller is installed on a bracket and can be easily removed by pushing it up. If the controller is supplied as a part of a filtration system, the controller is already installed and connected.

AlphaDisc™ CLD controller



To disassemble the installed controller:

1. Disconnect all cables and pipes (see 3.3 AlphaDisc™ CLD Terminal Blocks Connections and 3.4 AlphaDisc™ CLD DP Sensor Connections).
2. Push the controller up to remove it from the bracket.

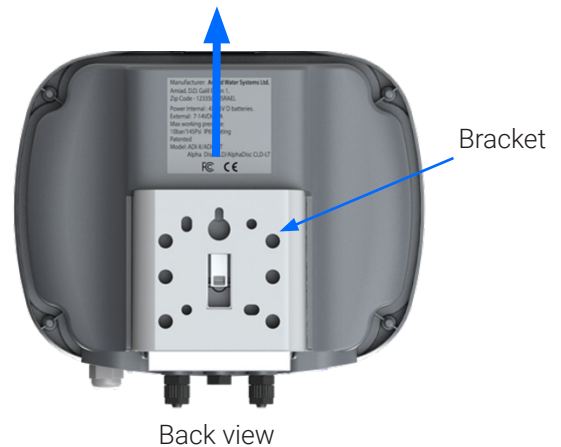

3.1 INSTALLATION ON A POLE

If the AlphaDisc™ CLD controller is supplied separately, it can be installed on a pole using a plate and clamps (not included).

Instructions:

1. Mount the 100x120 mm plate on the pole using clamps (minimum dimensions).
2. Remove the controller from the bracket (see Figure 3: Removing the AlphaDisc™ CLD controller from the bracket).
3. Tighten the bracket to the plate using 4 screws.

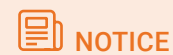
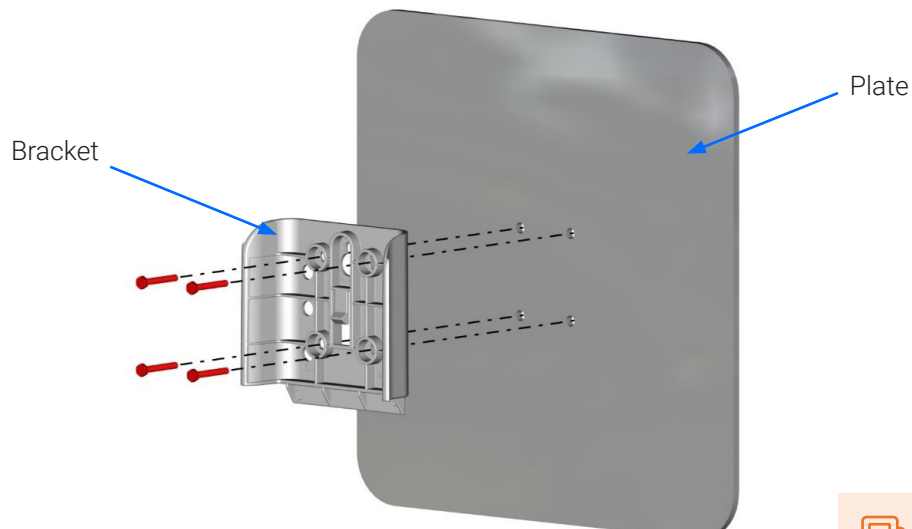

NOTICE

Handle with care

4. Attach the controller to the bracket. Press the controller until you hear "click".

3.2 INSTALLATION ON A WALL

If the AlphaDisc™ CLD controller is supplied separately it can be mounted on a wall using fasteners (not included).

Instructions:

1. Determine mounting height for easy viewing and access.
2. Remove the controller from its bracket (see Figure 3: Removing the AlphaDisc™ CLD controller from the bracket).
3. Attach the bracket to the wall. Level the bracket by using a water level.
4. Mark the location of the bracket holes on the wall (see fig. below).
5. Using a drill, install 4 wall anchors in the marked locations. Attach the bracket to the wall. Tighten the mounting screws into the anchors.

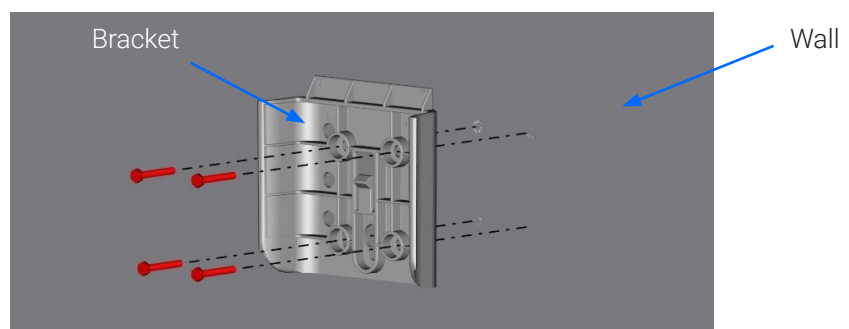

6. Attach the controller to the bracket. Press the controller until you hear "click".

3.3 ALPHADISC™ CLD TERMINAL BLOCKS CONNECTIONS

Once the controller has been installed, connect the controller's terminals according to the following:

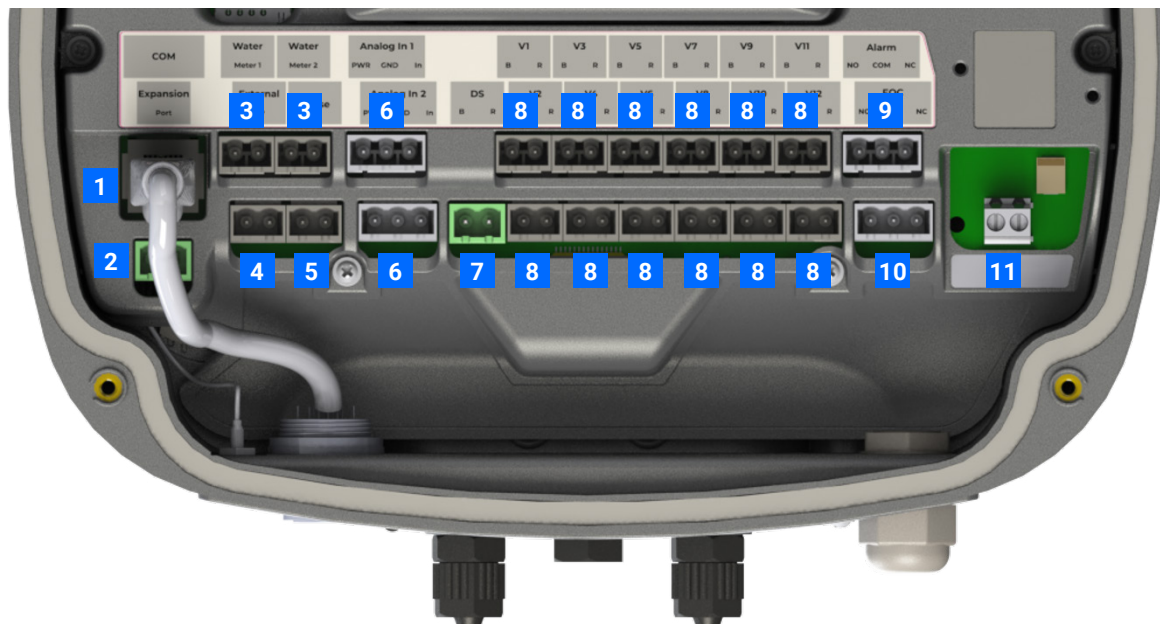

1. **RJ-45 COM:** Used to connect PLC or other control device.
2. **Extension A and B:** Used for connection between primary and secondary controllers (see 5.8).
3. **Digital inputs:** Used to connect external water meters.
4. **External DP:** Used to connect external differential pressure switch.
5. **Pause:** Used to connect external device to trigger pause.
6. **Analog inputs:** Used to connect analog signals 4-20 mA, 0-10 V (power to input is controlled) from sensors of following types: pressure, temperature, conductivity, turbidity, humidity.
7. **DS valve:** Output for downstream valve through solenoid latch.
8. **V1-V12 outputs:** For filter flush through solenoid latch.
9. **Alarm output:** Used to switch external device via NO/NC relay.
10. **End of cycle (EOC):** Used to send EOC signal via NO/NC relay.
11. **External power supply connection.** Power supply for the controller must supply 7-14 VDC, 2A.

In order to connect the cables to the controller's terminals, remove the top cover by loosening the four screws.



Remove the two screws that secure the electrical safety protection cover. This will allow access to connect the external power supply.



 **NOTICE**

the connection cables enter the controller case via silicon insulated holes. Once the silicon insulation is broken by the cable it will no longer provide sufficient insulation without cable. Do not remove cables from entrance holes without replacing them with the new ones!

 **NOTICE**

every external device connected to the controller should be correctly set up in controller settings (see 5.3). For example: number of filtration units must be specified correctly; type of analog device connected to the controller must be specified in corresponding field.

3.4 ALPHADISC™ CLD DP SENSOR CONNECTIONS

The AlphaDisc™ CLD controller can work with an internal or external DP sensor, depending on configuration. The controller's default configuration is the internal DP sensor. Water pipes should be connected to the DP inlet and outlet (See Figure 1: AlphaDisc™ CLD controller components).



3.5 BATTERIES INSTALLATION/REPLACEMENT

The AlphaDisc™ CLD controller controller is supplied with 4 x 1.5V Type D batteries supplied loose. The estimated batteries' lifetime is one year or about 80K flushes (whichever comes first).

To install/replace the batteries:

1. Remove the top cover by loosening the four screws.



2. Remove the two screws that secure the battery cover. This will allow access to the battery assembly.



3. Remove the battery assembly from the device and replace 4 x 1.5V Type D batteries.



4. Reinstall the battery assembly.
5. Close battery cover and tighten the screws.
6. Reassemble the top cover and tighten the screws.

4. AlphaDisc™ CLD Desktop, AlphaDisc™ CLD Mobile, and AlphaDisc™ BLE Mobile Applications

The AlphaDisc™ CLD controller can be controlled by three applications as follows:

1. **AlphaDisc™ CLD Desktop application** connects to the controller via the cloud. It allows you to operate your controller by remote access.

To access the AlphaDisc™ CLD Desktop application go to the AlphaDisc™ CLD page in Netafim.com website.

2. **AlphaDisc™ CLD Mobile application** connects to the controller via the cloud. It allows you to operate your controller by remote access.

3. **AlphaDisc™ BLE Mobile application** connects to the controller via Bluetooth® wireless technology.

The mobile device should be within a range of 10-15 meters from the controller. This application does not require or support cloud services.

The free AlphaDisc™ BLE and AlphaDisc™ CLD mobile applications by Netafim are available for download on Google Play (Android version 5 and up) or the App Store (iOS version 9 and up).

4.1 APPLICATIONS PREPARATION

4.1.1 AlphaDisc™ CLD Desktop Application Sign Up

To create a new AlphaDisc™ CLD account:

1. Click **SIGN UP**

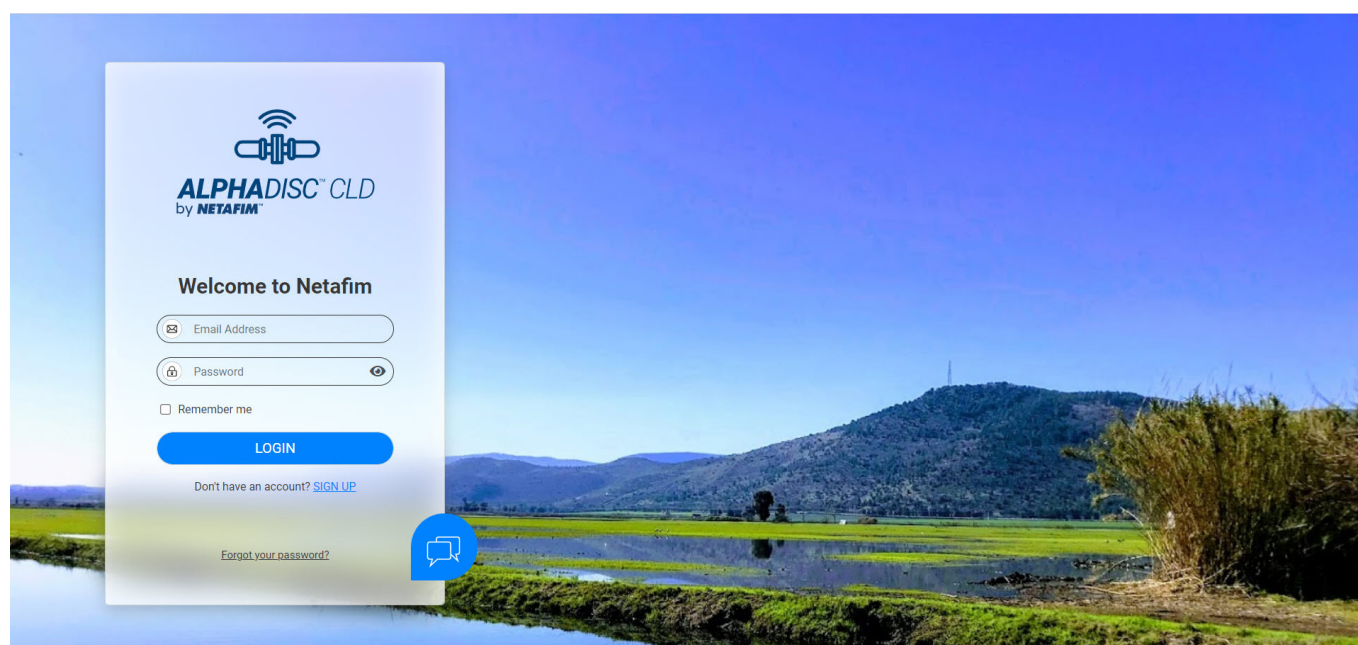

2. Enter your Email address and click **SEND**.

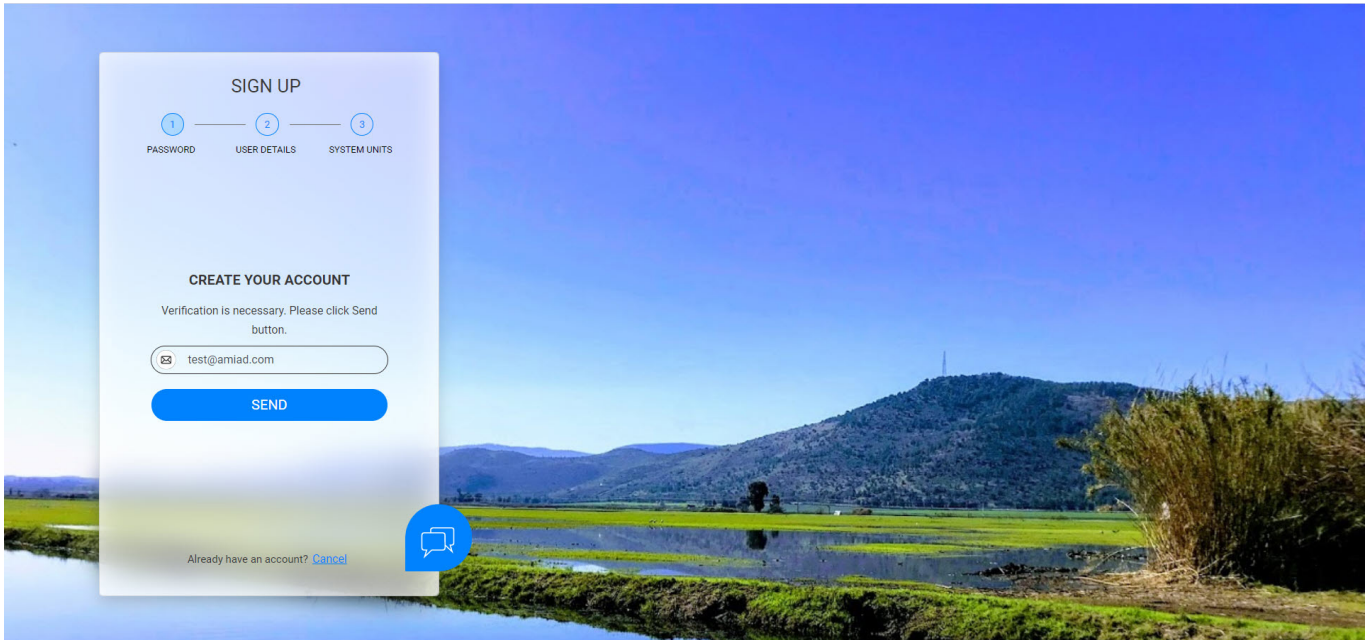

3. A verification code will be sent to your Email. Enter the «Verification code» and click **Verify code**.

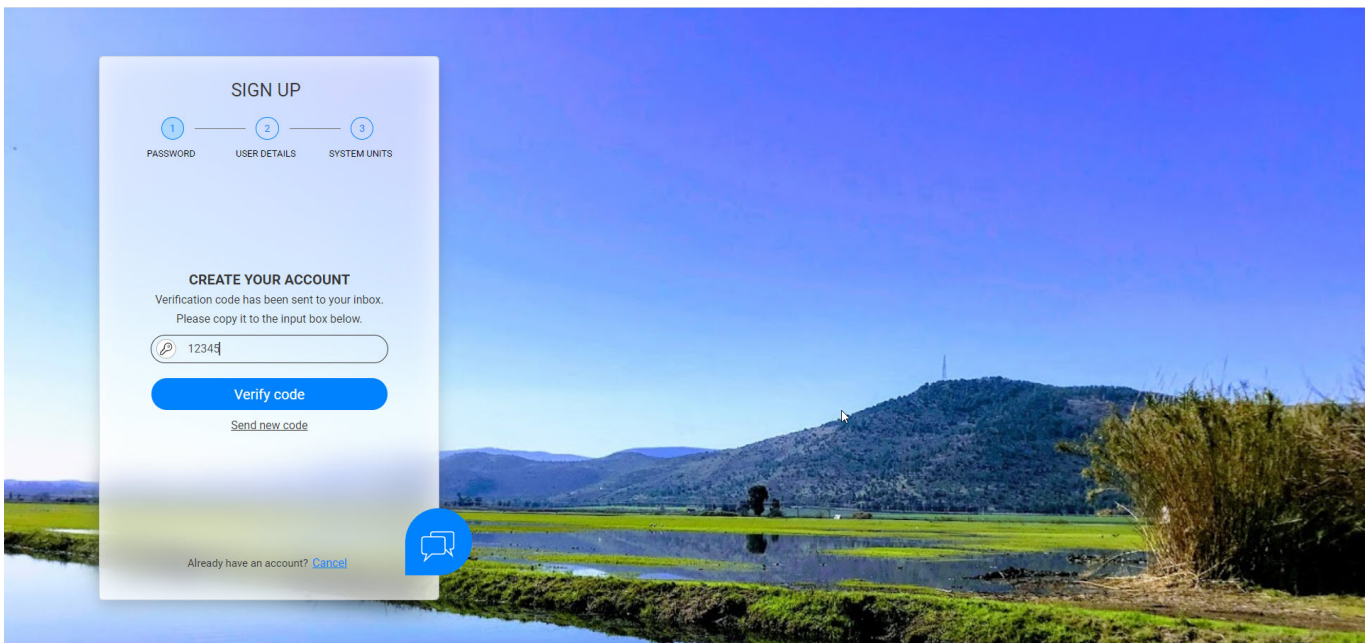

4. Create your new password in the **New Password** field and reenter the new password in the **Confirm New**

Password field. Remember your password! Click **Create**.

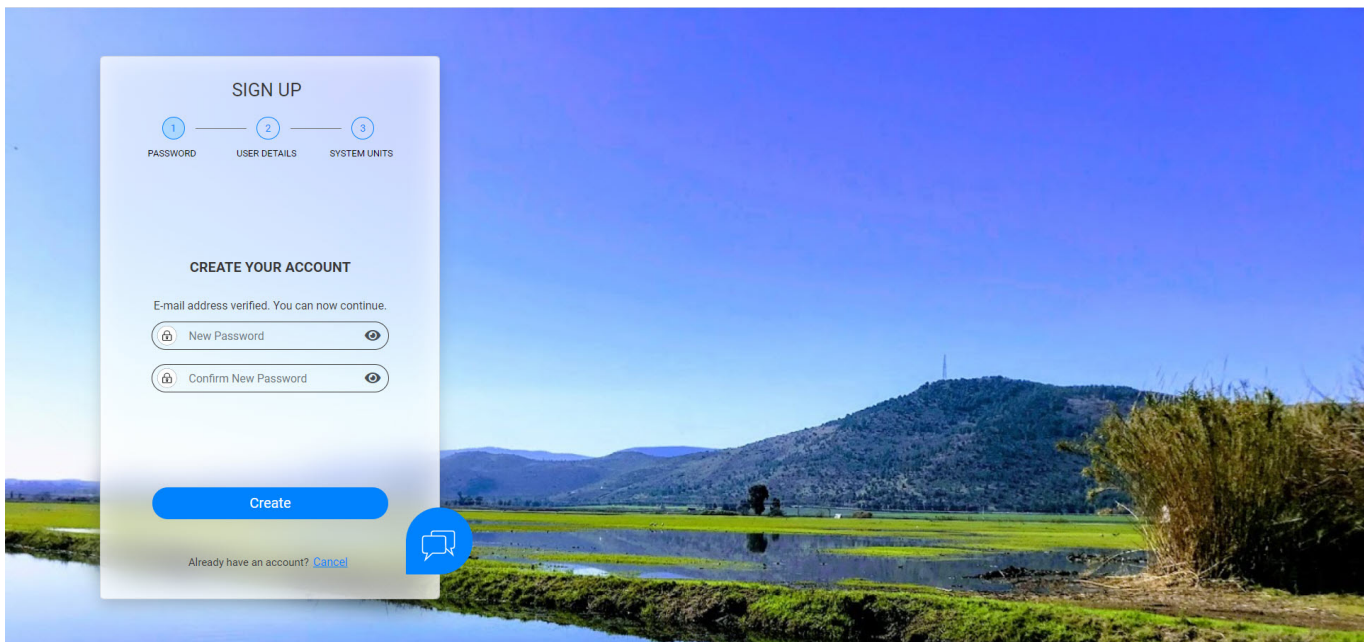

5. Enter your Full Name, Country, Company and Job Description. Click **Next**.

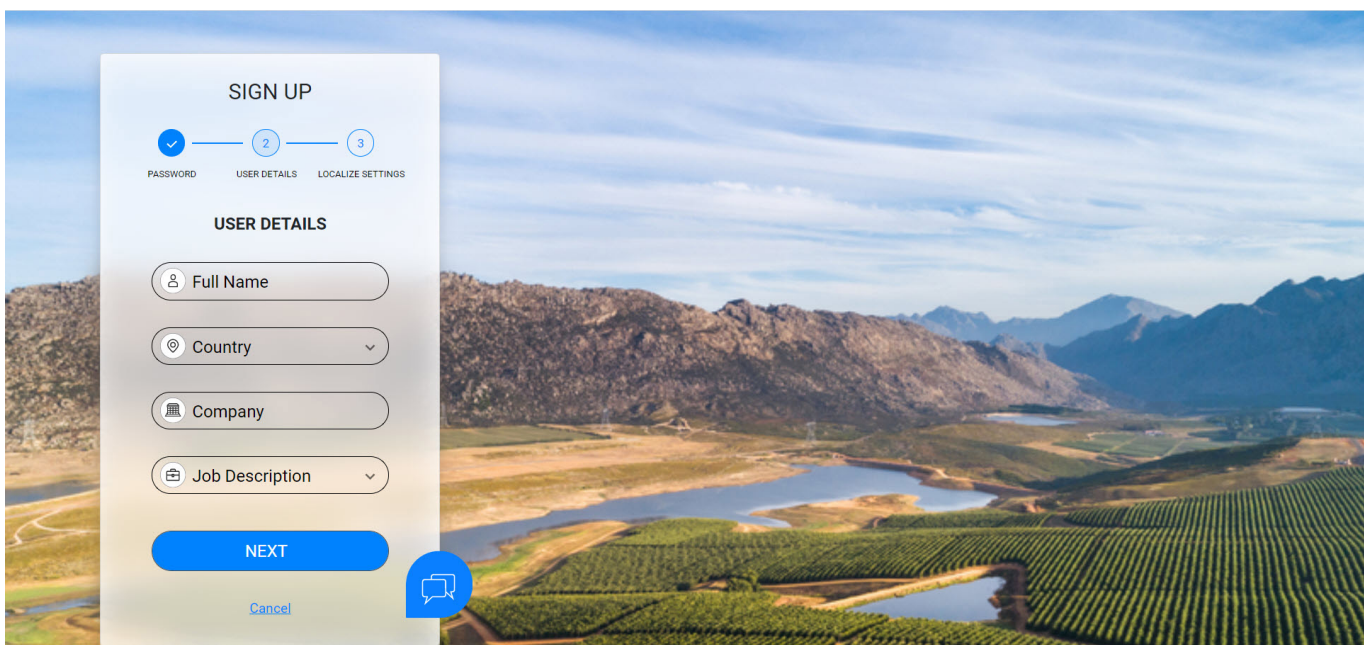

6. Select your application language and units (METRIC or IMPERIAL). Click **SUBMIT**.



7. Your AlphaDisc™ CLD account was created!

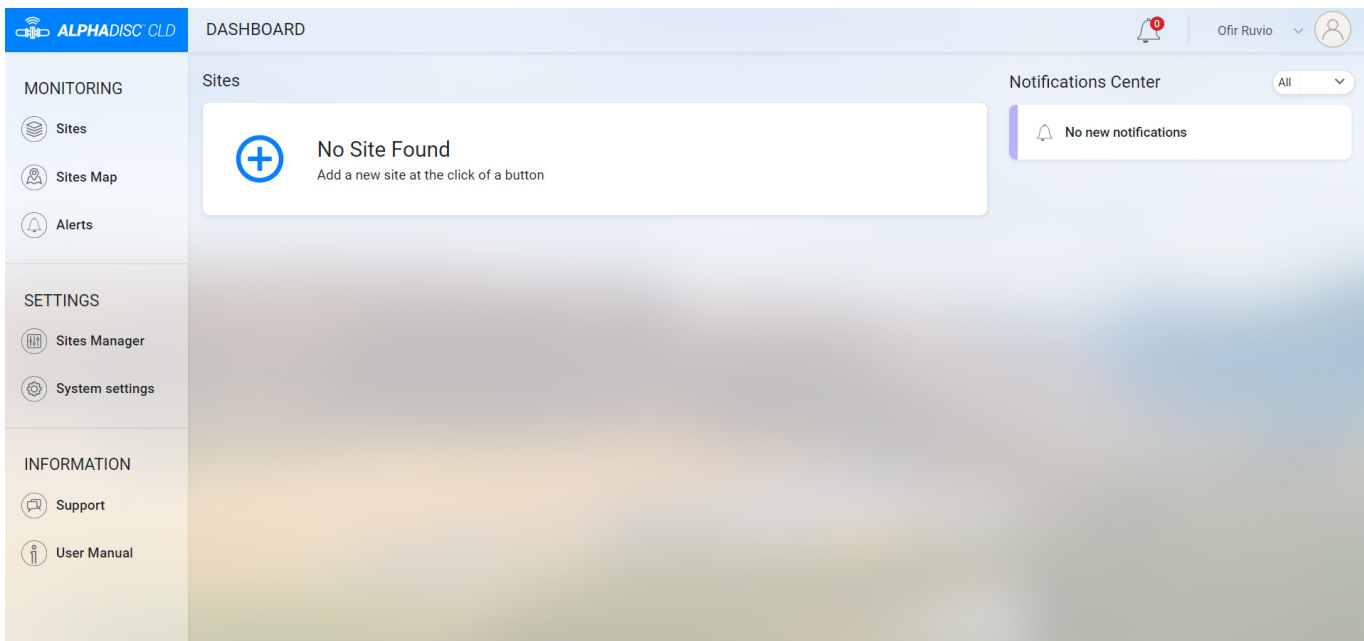

4.1.2 AlphaDisc™ CLD Mobile Application Log In

Download and install the AlphaDisc™ CLD Mobile application on your mobile device.

Log in using Email and password created earlier (see 4.1.1).1.

1. Enter your Email (used for signing up in AlphaDisc™ CLD Desktop application). Click **CONTINUE**.

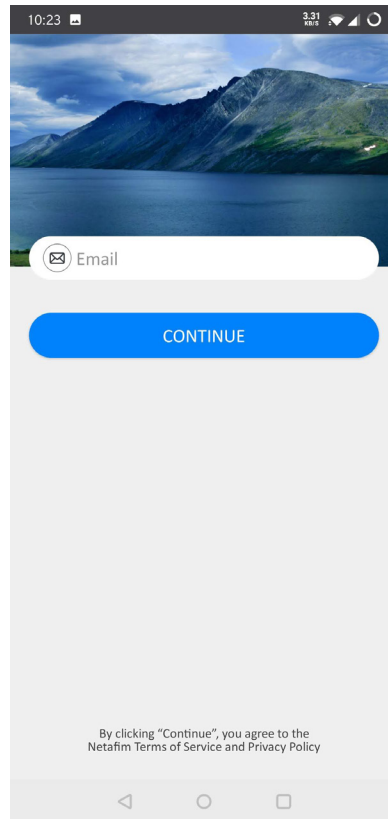

2. Enter your password (created during sign up in AlphaDisc™ CLD Desktop application),. Click **SUBMIT**.

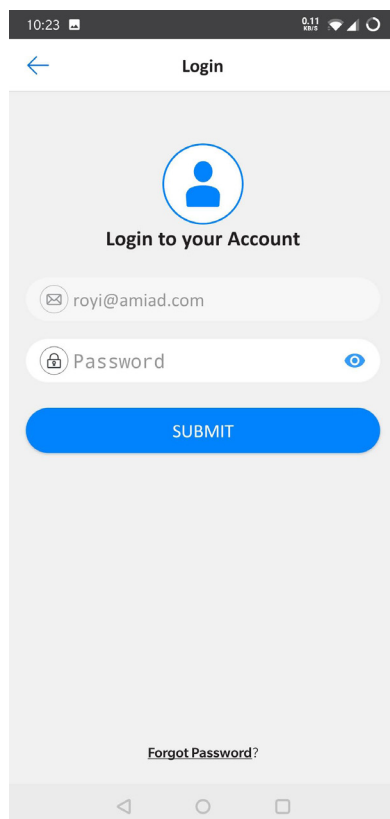

4.1.3 AlphaDisc™ BLE Mobile Application Registration

Download and install the AlphaDisc™ BLE Mobile application on your mobile device. To register your account in the AlphaDisc™ BLE application:

1. Activate your phone's Bluetooth® discovery mode and start the AlphaDisc™ BLE application.
2. Click **OK** to start setting up your account.

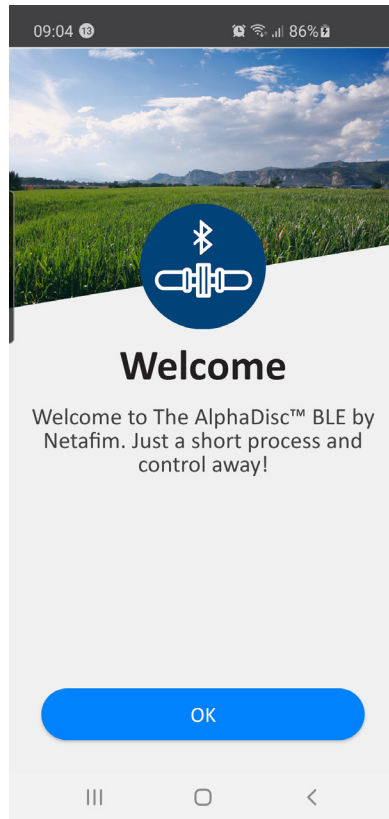

3. Select your preferred system units (Metric or Imperial and click **OK**.

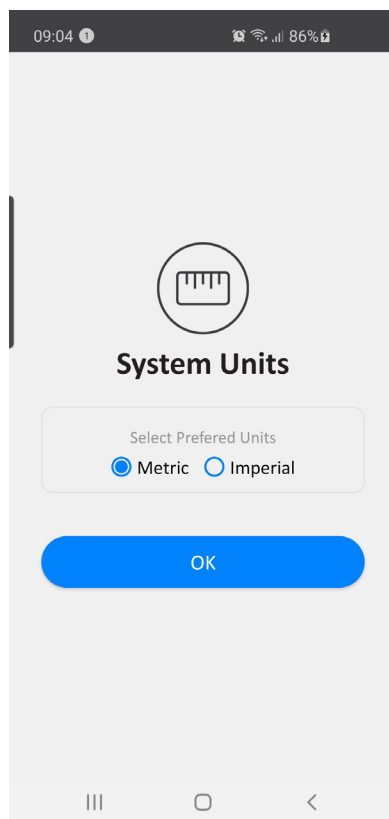

4. Enter your Full Name, Email, Country, Company, and Job Description. Click **SUBMIT**.
To skip this step click **SKIP** in the upper right corner (completing these steps is recommended for better support).

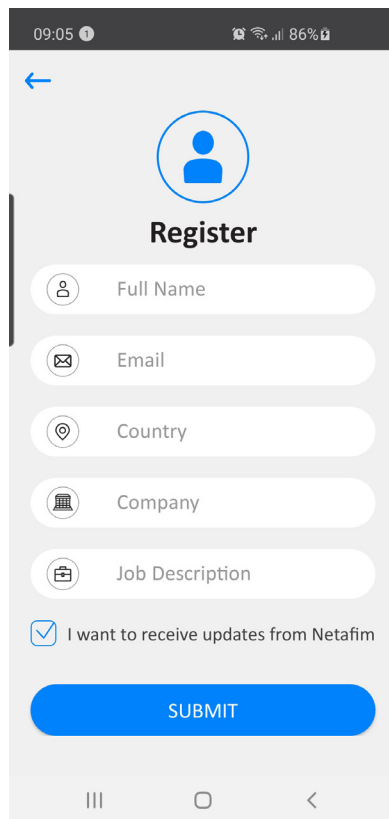

A screenshot of a mobile application registration screen. At the top, the status bar shows the time 09:05, signal strength, Wi-Fi, and 86% battery. Below the status bar is a blue back arrow. The main heading is "Register" with a blue person icon above it. There are five input fields: "Full Name" (with a person icon), "Email" (with an envelope icon), "Country" (with a location pin icon), "Company" (with a building icon), and "Job Description" (with a briefcase icon). Below the fields is a checked checkbox with the text "I want to receive updates from Netafim". At the bottom is a large blue "SUBMIT" button. The Android navigation bar is visible at the very bottom.

5. At this stage, your account was successfully created and is ready use.

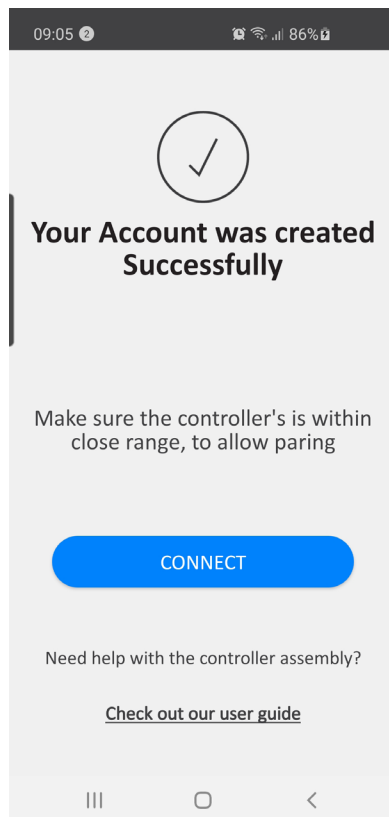

4.2 ADDING ALPHADISC™ CLD CONTROLLER TO A USER ACCOUNT

Adding an AlphaDisc™ CLD controller to your user account can be done using the AlphaDisc™ CLD Desktop application or the AlphaDisc™ CLD Mobile application. When the controller is added to your account it will be reflected on both applications.

The AlphaDisc™ CLD controller can be added only to a single account – the owner account.

The owner can share the AlphaDisc™ CLD controller with other users (see 5.2 AlphaDisc™ CLD Controller Sharing).

To add your AlphaDisc™ CLD controller to your account, you need to set the AlphaDisc™ CLD controller in communication mode and get the specific PIN code displayed, by following these instructions:

1. Open the AlphaDisc™ CLD controller display protection cover.
2. If needed, Press the Left Button to enable LED backlight.
3. Press and hold the Left Button on the AlphaDisc™ CLD controller until the 8-digit PIN code appears on the screen.

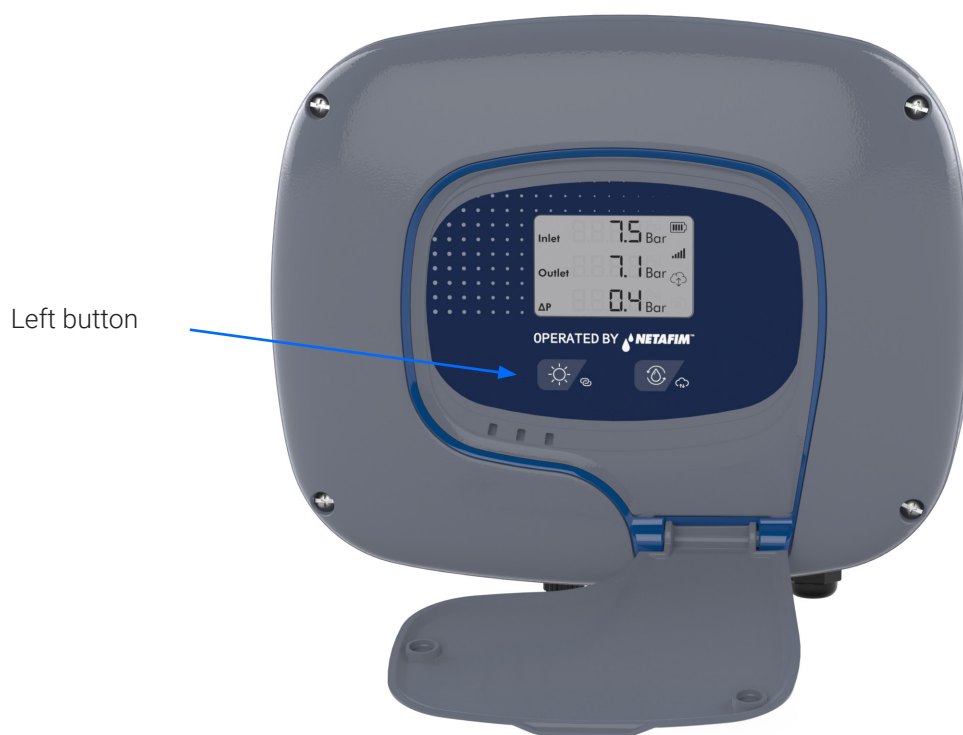

4.2.1 Adding AlphaDisc™ CLD Controller using the AlphaDisc™ CLD Desktop Application

To add the AlphaDisc™ CLD controller to your account using AlphaDisc™ CLD Desktop application:

1. Open AlphaDisc™ CLD Desktop application. Sign in with your email and password.
2. Click **+** on the Home page (only for the first controller)

or go to the **Sites manager** tab in the left menu and click **ADD SITE**.

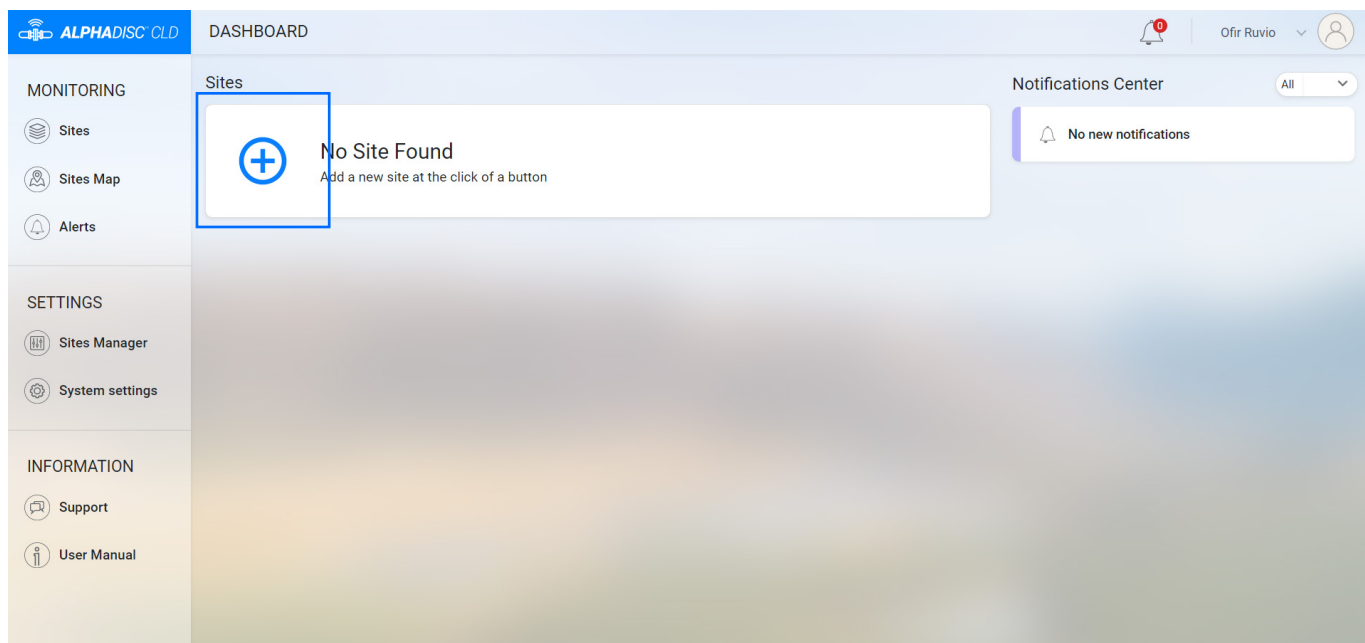
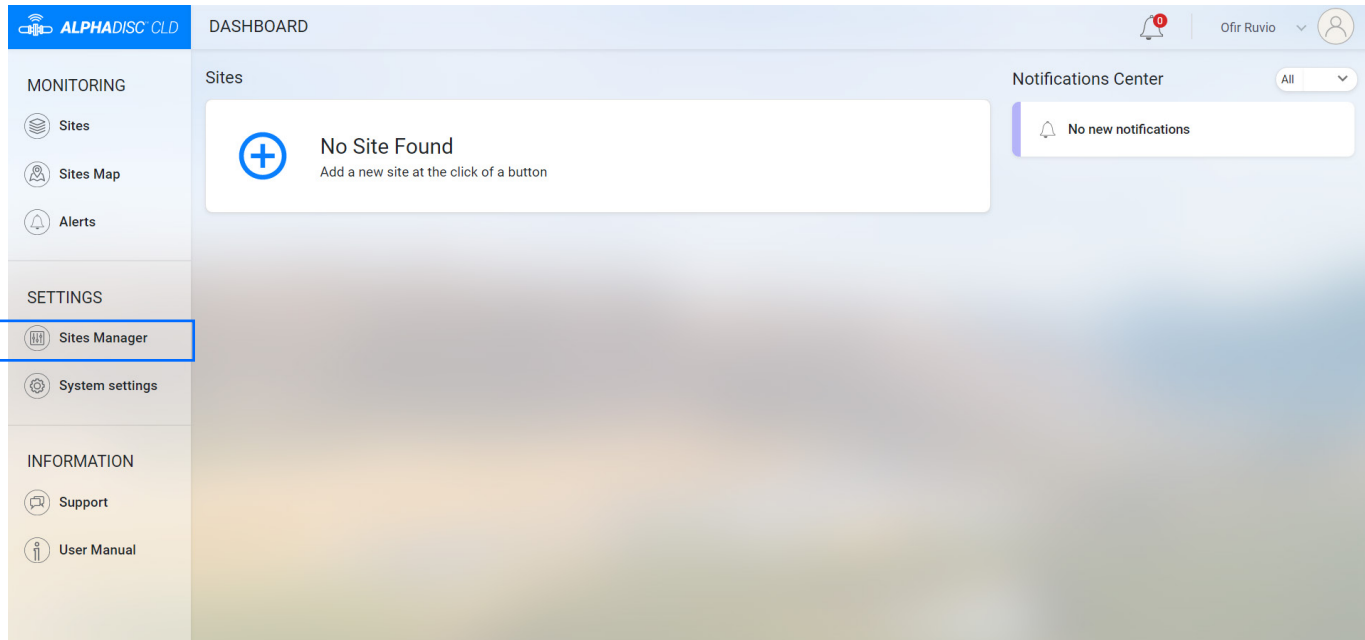

3. Make sure that the AlphaDisc™ CLD controller is turned on and is in communication mode. Enter the 8-digit PIN code obtained from the controller. Click **NEXT**.

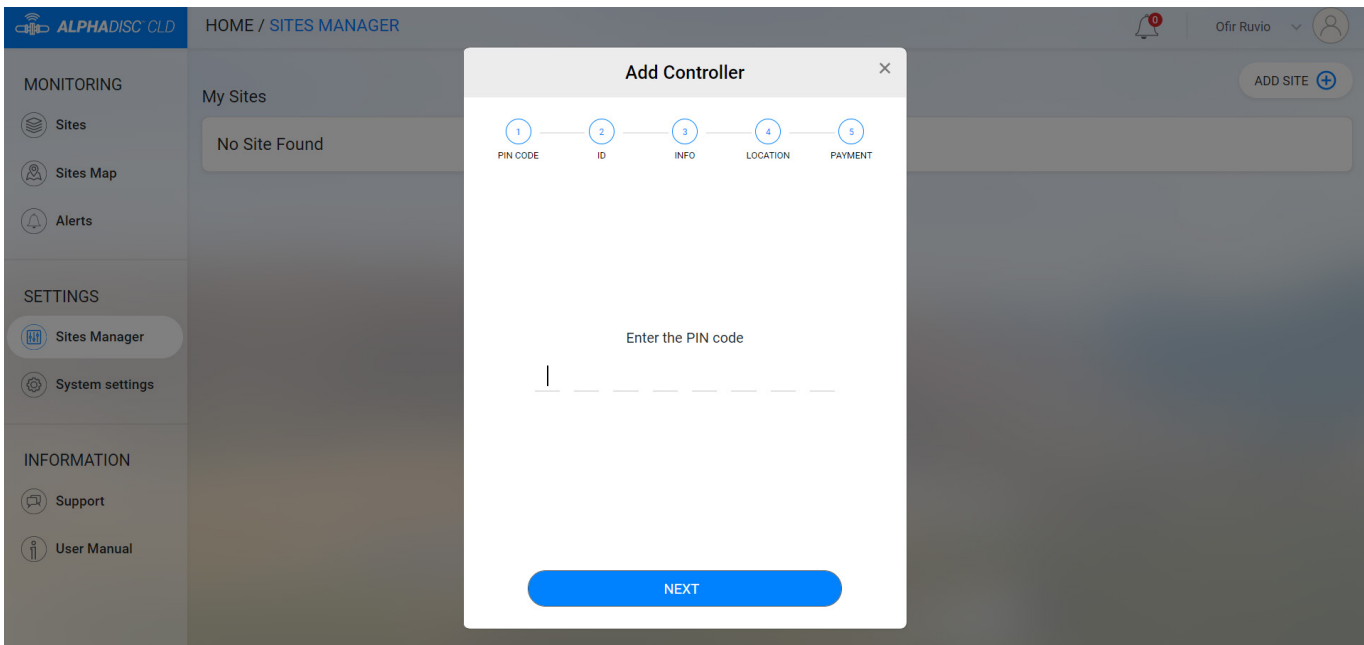

4. In **Site Id** window fill in the **Name Your Site** field, select a Filter Model from the list, enter filter serial number in **Filter Serial Number** field, add site picture by clicking **Add site image**, Click **NEXT**.

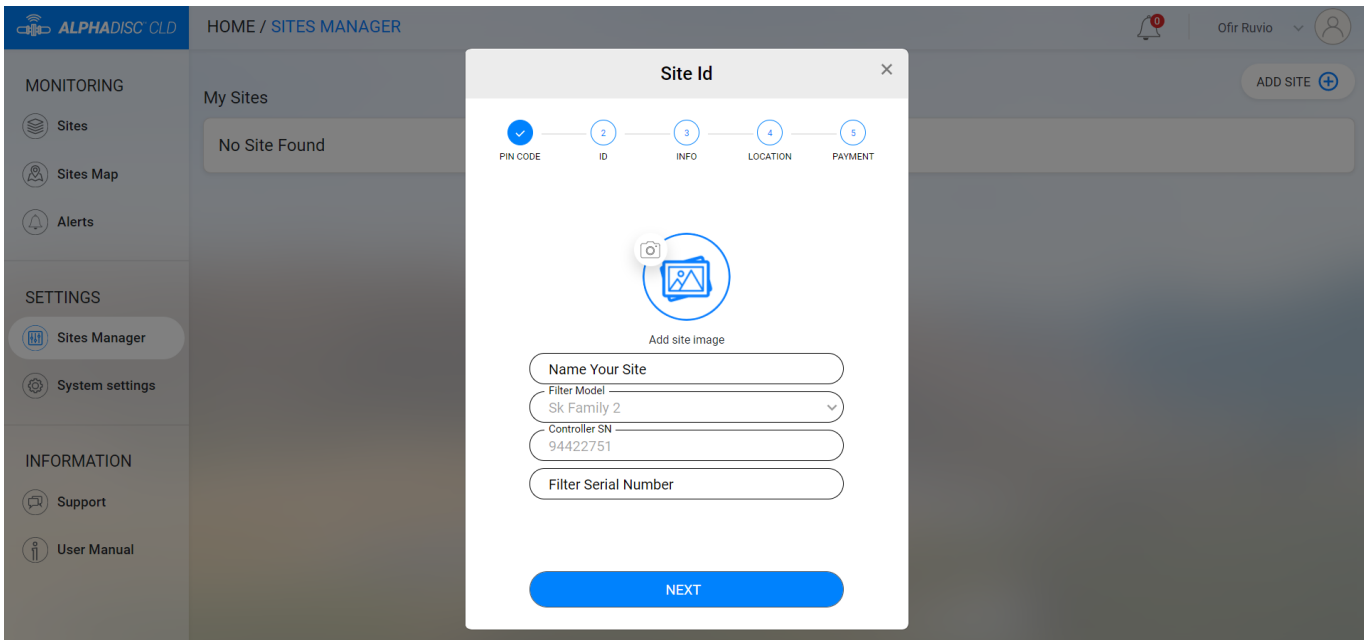

5. In the **Site Information** window select Water Source from the list, enter flow rate in **Flow Rate (m³/h)** field, enter working pressure in **Working Pressure (BAR)** field, select Filtration Degree from the list, Click **NEXT**.

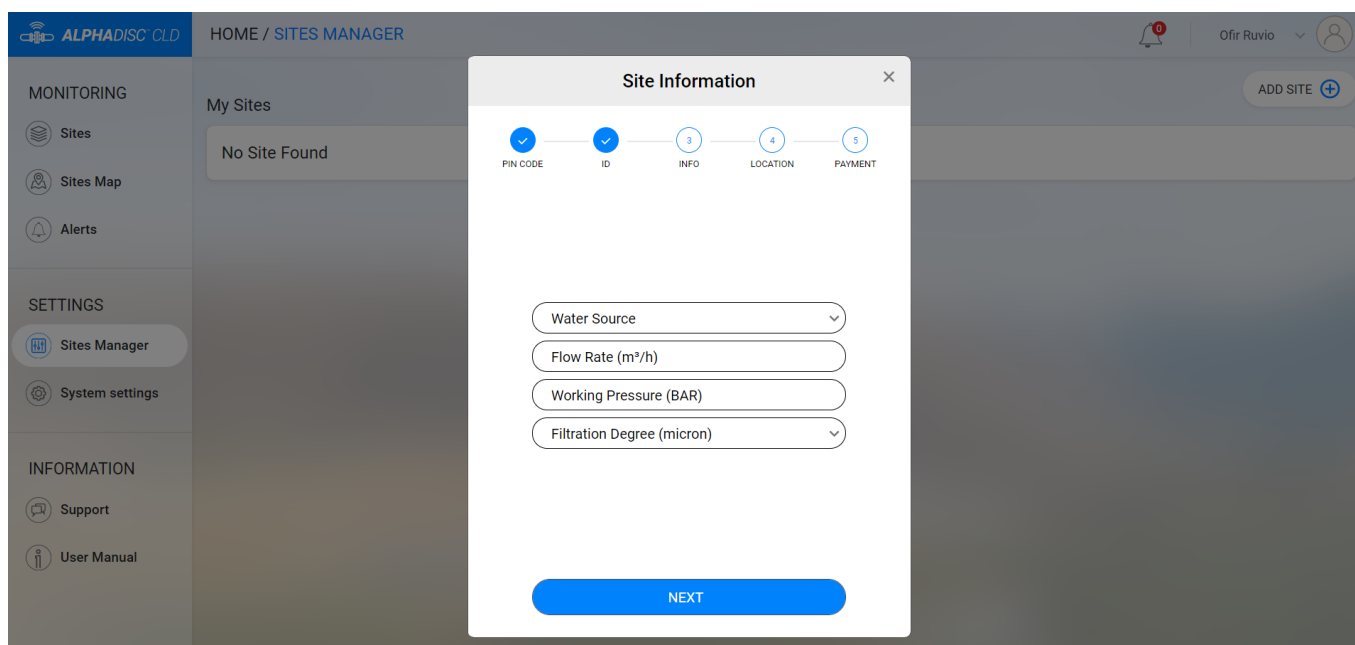

6. In **Site Location** window set the location of the site on the map, Click **SUBMIT**.

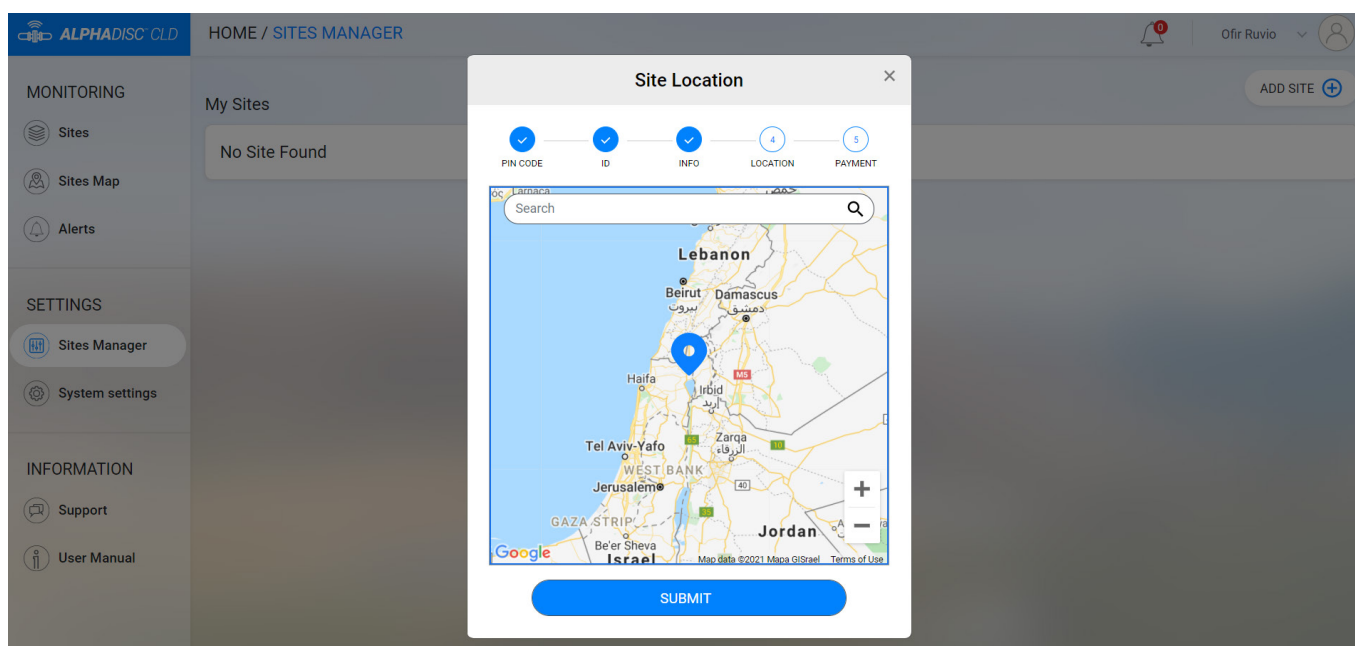

7. In **Payment** window you should confirm the payment notice. At this stage, your controller is connected to your account and ready for use! Click **NEXT**.

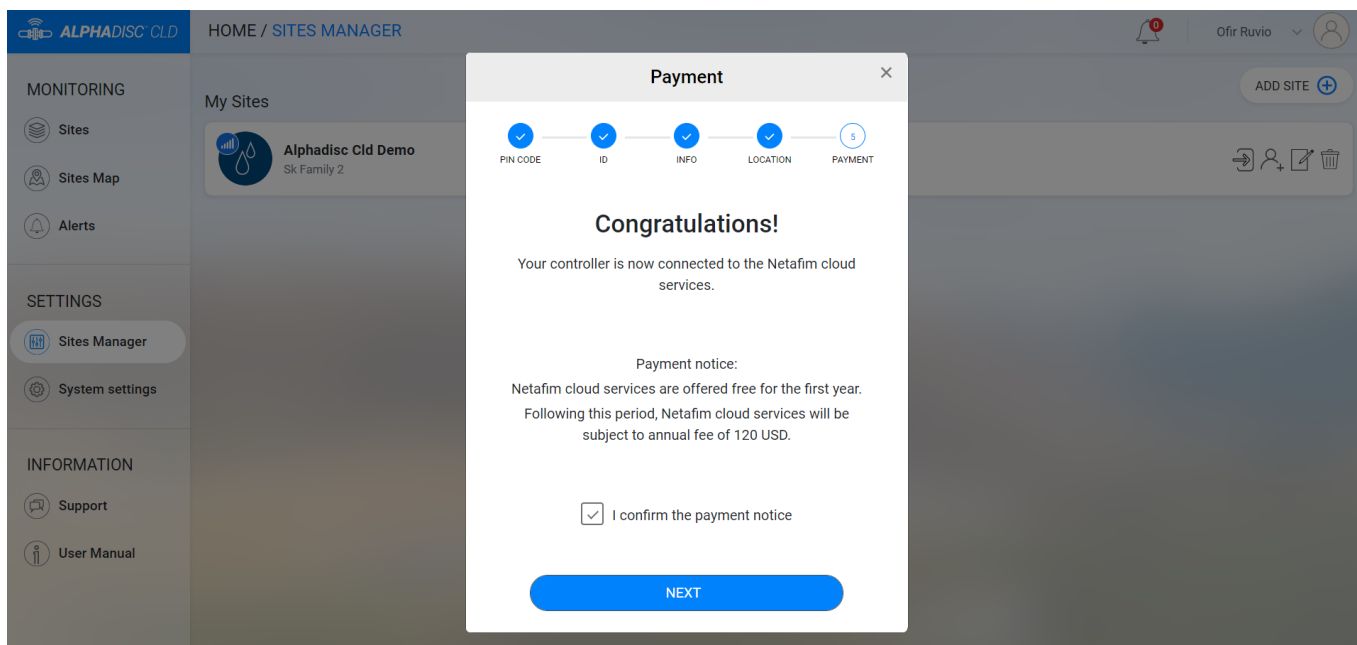

8. In **Site Added** window your AlphaDisc™ CLD is ready to use. Click **CONTINUE**.

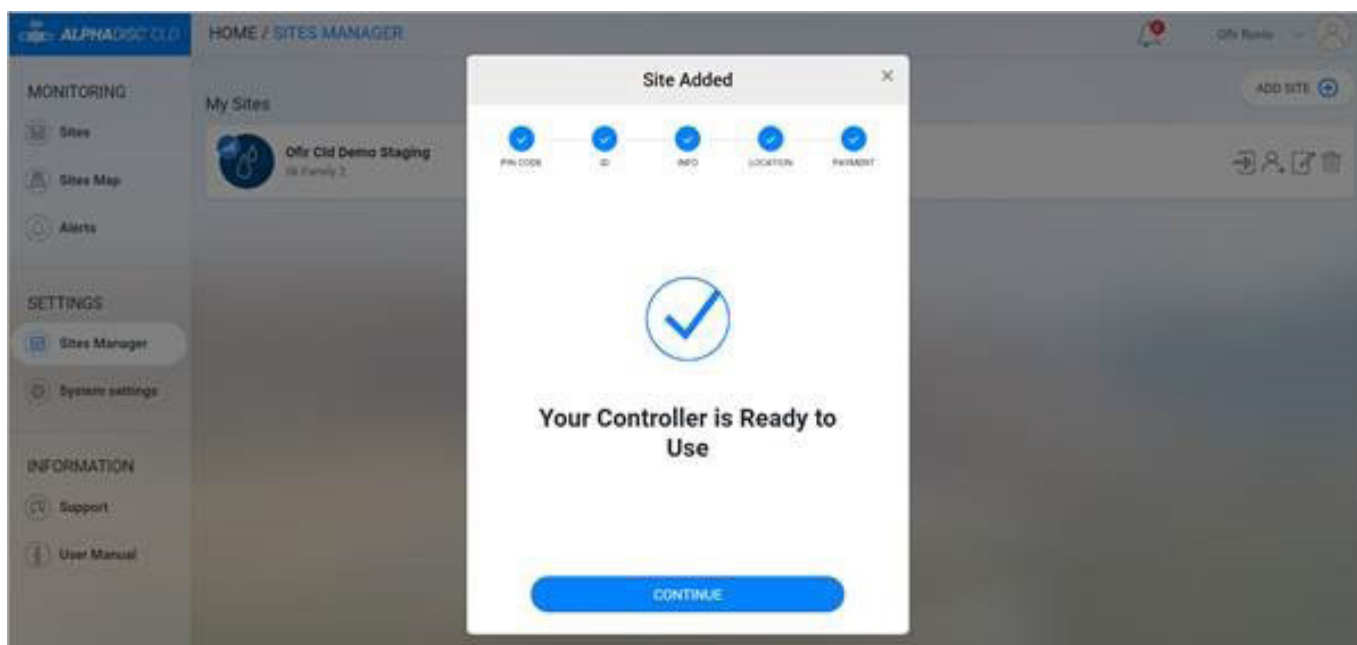

9. To view data from your controller, select the desired controller from **Sites List** on Sites page (see 4.3.3.2).

4.2.2 Adding AlphaDisc™ CLD Controller using the AlphaDisc™ CLD Mobile Application

To add the controller to your user account using AlphaDisc™ CLD Mobile Application:

1. Open the AlphaDisc™ CLD Mobile Application. Sign in with your email and password.
2. Click the  in the **List of Sites** window.

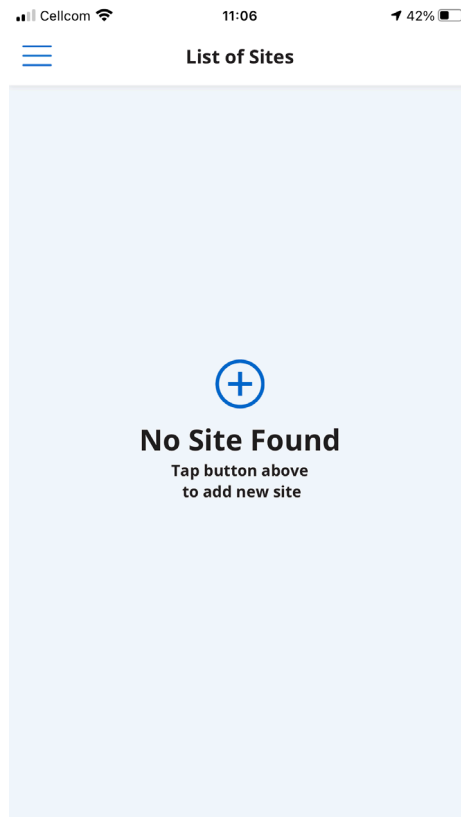

3. Make sure the controller is turned on and in communication mode. Enter the 8-digit PIN code obtained from the controller. Click **NEXT**.

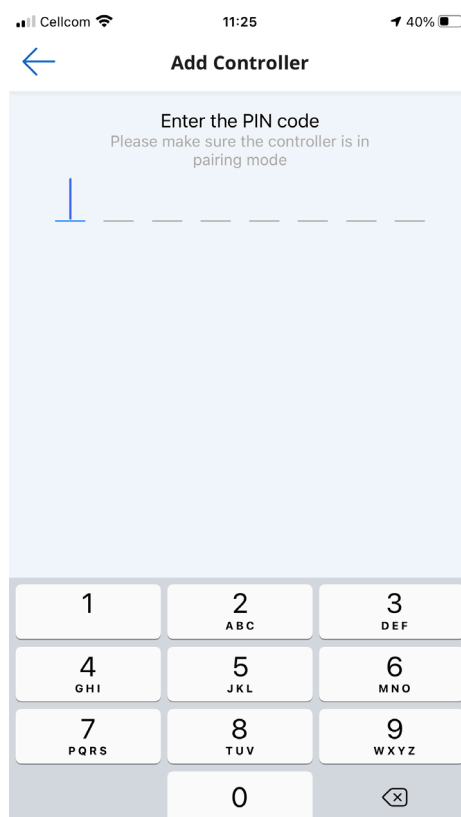

4. In **Site ID** screen enter your site name in the **Name Your Site** field, select filter model from the list, enter filter serial number in **Filter Serial Number** field, add site picture by clicking the Site image icon. Click **NEXT**.

The screenshot shows the 'Name Your Site' screen. At the top, the status bar displays 'Cellcom', '11:26', and '40%' battery. The screen has a light blue background. The title 'Name Your Site' is centered at the top. Below it are four input fields, each with a circular icon on the left: a pencil for editing, a refresh for selection, a barcode for scanning, and a barcode for scanning. The first field contains 'AlphaCLD Demo', the second 'Spinklin Nova', and the third '17101747'. The fourth field is empty. Below the fields are three dots indicating a progress indicator. At the bottom is a large blue button with the text 'NEXT'.

5. In **Site Information** screen select water source from the list, enter flow rate in **Flow Rate (m³/h)** field, enter working pressure in **Working Pressure (BAR)** field, select filtration degree from the list. Click **NEXT**.

The screenshot shows the 'Site Information' screen. At the top, the status bar displays 'Cellcom', '11:26', and '40%' battery. The screen has a light blue background. The title 'Site Information' is centered at the top, with a blue back arrow on the left. Below it are four input fields, each with a circular icon on the left: a water tap for 'Water Source', a water drop for 'Flow Rate (m³/h)', a pressure gauge for 'Working Pressure (BAR)', and a dropdown menu for 'Filtration Degree (micron)'. The dropdown menu shows options: 80, 100, 130, 200, and Other. Below the fields are three dots indicating a progress indicator. At the bottom is a large blue button with the text 'NEXT'.

6. In **Site Location** screen set the location of the site on the map. Click **NEXT**.



7. In **Payment** window you should confirm the payment notice. At this stage, your controller is connected to your account and ready for use! Click **NEXT**.

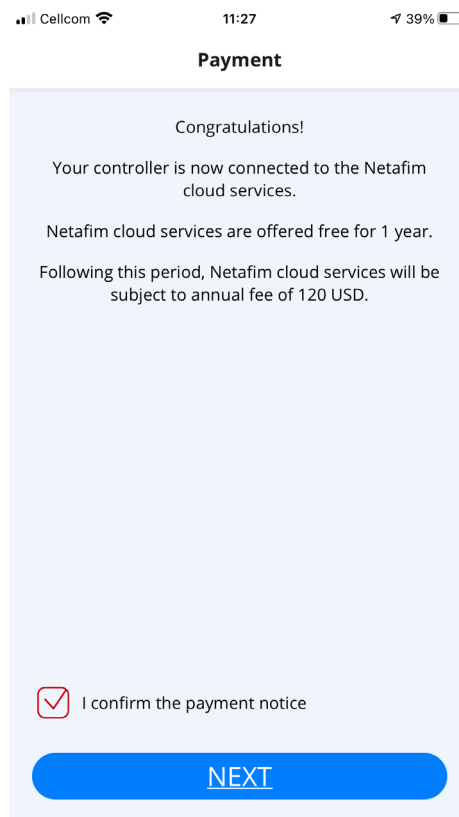

8. At this stage your controller was connected to your user account and ready for use! Click **SUBMIT**.

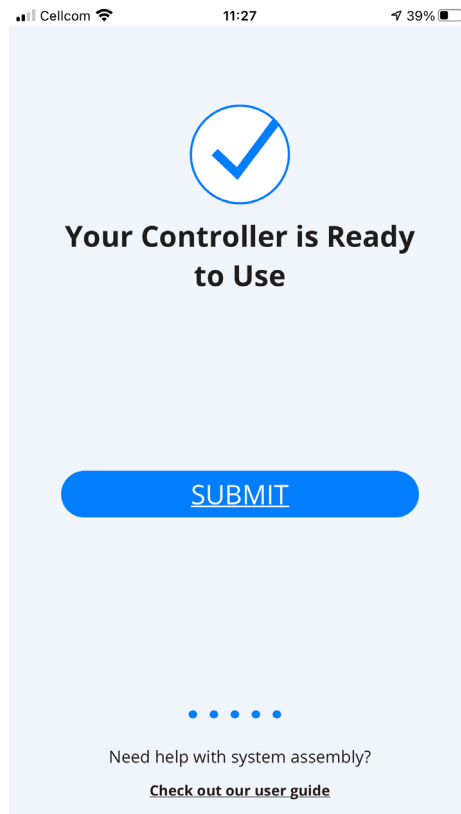

9. To view data from your controller, select the desired controller from **Sites List** on Sites screen (see 4.4.3.1).

4.2.3 Pairing AlphaDisc™ CLD Controller with the AlphaDisc™ BLE Mobile Application

NOTICE

Pairing the AlphaDisc™ CLD controller with the Bluetooth® application will utilize part of the full list of features available in the cloud applications. Netafim recommends pairing the AlphaDisc™ CLD controller with the dedicated AlphaDisc™ CLD applications (Mobile and Desktop).

To pair the controller with the AlphaDisc™ BLE Mobile Application:

1. Verify your mobile device's Bluetooth® discovery mode is activated.
To start pairing with the controller click  in window.
The application scans for controllers within Bluetooth® range (10-15 meters).

2. Select your controller from the controllers list in range.
The application will start pairing.

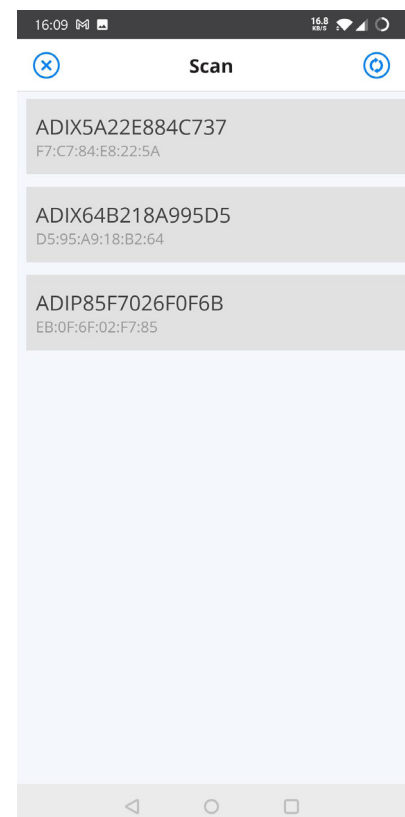
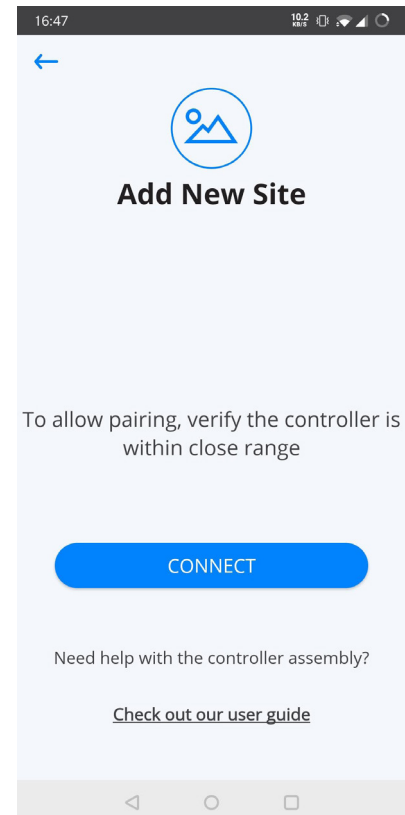

3. Verify that the blue/green LED on your controller is blinking.
Click **YES** to confirm.

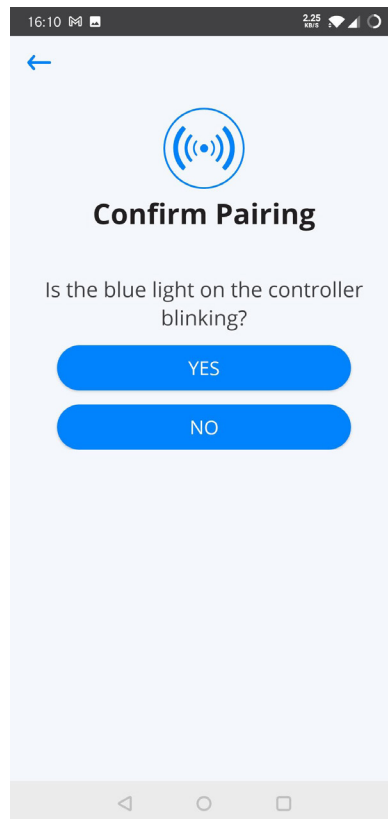

4. At the end of the pairing process, complete the Site ID form: name your site, enter filter model and controller serial number if needed. You may add a site photo by clicking on **Add Photo**. Click .

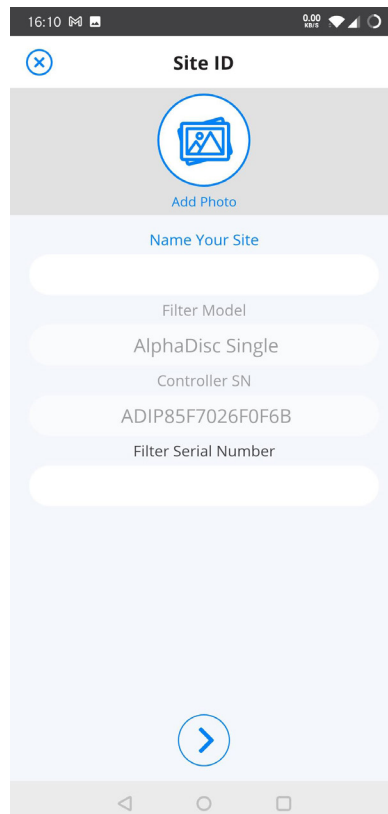

5. Enter the Site Information details (optional), Click **SUBMIT** to add your new filter to the Sites List.

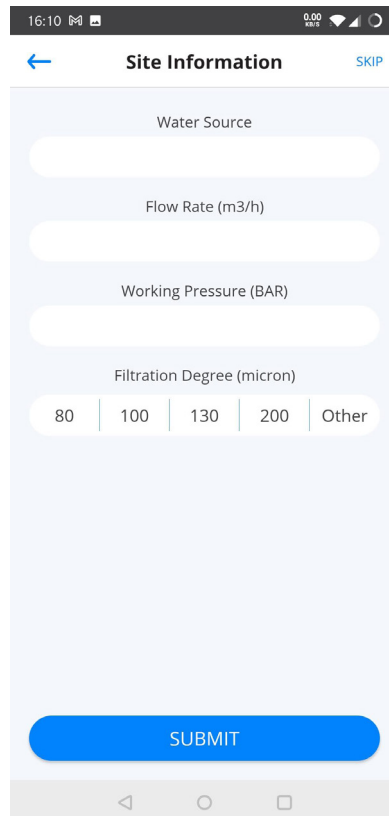

6. To view data from your controller, select the active controller from the **Sites List**, marked by the active Bluetooth® icon.

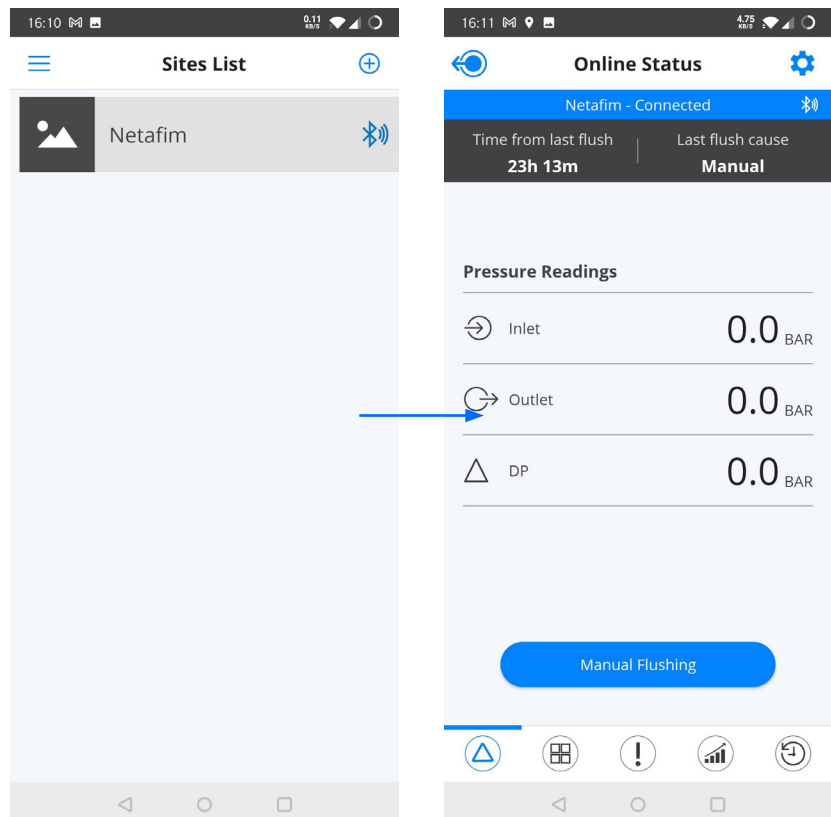

4.3 GETTING TO KNOW THE ALPHADISC™ CLD DESKTOP APPLICATION

Take a few moments to familiarize yourself with the AlphaDisc™ CLD Desktop Application interface:

AlphaDisc™ CLD Desktop Application has seven main pages. Each page contains the Left menu for navigating between the pages, Header line, and Page content that changes from page to page.

See details in the following tables:

4.3.1 Left Menu Details

ELEMENT	DESCRIPTION
MONITORING SITES	THE SITES PAGE CONTAINS A LIST OF ALL OWNED AND LINKED SITES AS WELL AS SITES OVERVIEW AND SETTINGS. SEE 4.3.3.2.
MONITORING SITES MAP	THE SITES MAP PAGE CONTAINS A MAP WHERE ALL OWNED AND LINKED SITES ARE MARKED. SEE 4.3.3.3
MONITORING ALERTS	THE ALERTS PAGE CONTAINS ACTIVE ALERTS FROM ALL CONNECTED CONTROLLERS AND A LIST OF ALERT MESSAGES ACCORDING TO THEIR OCCURRENCE TIME AND DATE. SEE 4.3.3.4.
SETTINGS SITES MANAGER	THE SITES MANAGER PAGE CONTAINS A LIST OF ALL OWNED AND LINKED SITES AND ALLOWS ADDING AND DELETING SITES FROM THE ACCOUNT. SEE 4.3.3.5.
SETTINGS SYSTEM SETTINGS	THE SYSTEM SETTINGS PAGE CONTAINS ACCOUNT PARAMETERS, LOCALIZATION PARAMETERS AND ALLOWS CHANGING THE USER PASSWORD. SEE 4.3.3.6.
INFORMATION SUPPORT	THE SUPPORT CONTAINS A MESSAGE POP-UP WINDOW. SEE 04.3.3.7.
INFORMATION USER MANUAL	THE USER MANUAL CONTAINS A LINK TO THE DIGITAL VERSION OF THE USER MANUAL. SEE 4.3.3.8.

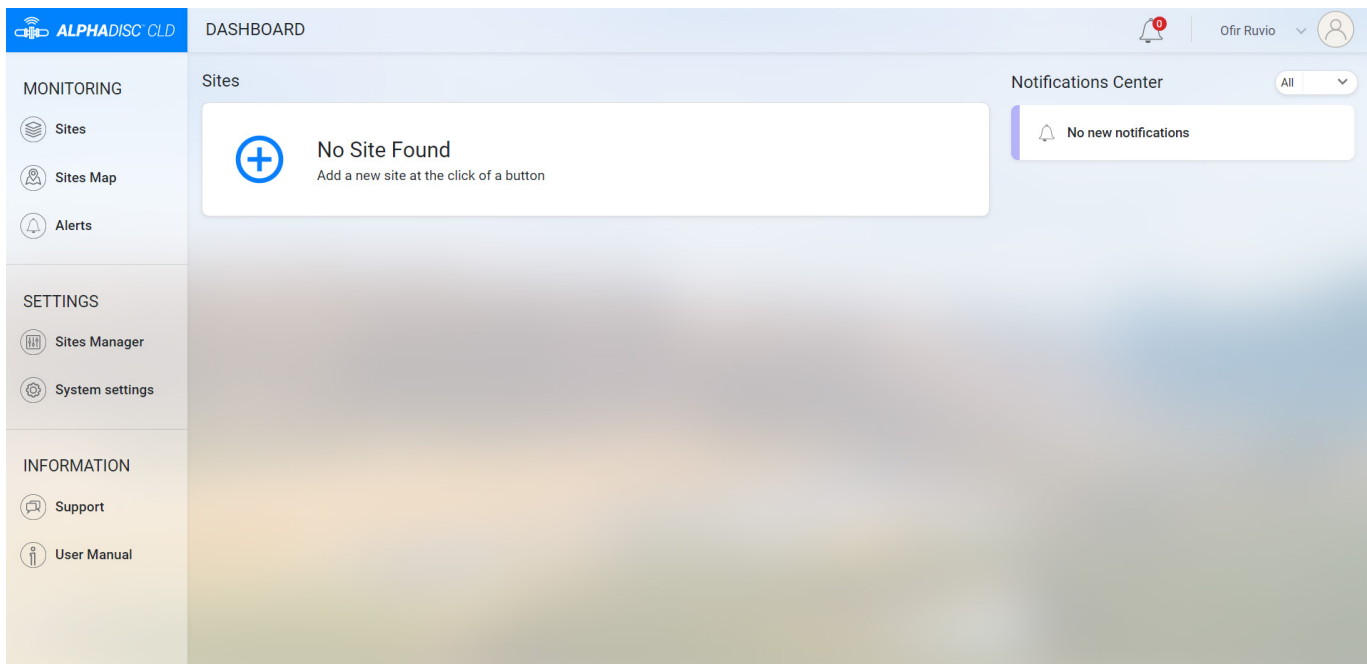

4.3.2 Header Line Details

ELEMENT	DESCRIPTION
PAGE NAME	DISPLAYS THE CURRENT PAGE NAME WITH THE NAVIGATION PATH. EXAMPLE: HOME/SYSTEM SETTINGS/MY ACCOUNT.
ALERTS ICON	SHOWS THE NUMBER OF ACTIVE ALERTS.
USERNAME	SHOWS THE USERNAME.
DROP DOWN MENU	USERNAME DROP-DOWN MENU, CONTAINS TWO OPTIONS: MY ACCOUNT – OPENS SYSTEM SETTINGS PAGE. SEE 4.3.3.6. SIGN OUT – ALLOWS THE USER TO SIGN OUT OF THE ACCOUNT.

4.3.3 Page Details

4.3.3.1 Home/Dashboard Page

Home page is displayed after log in. You can return to Home page by clicking “Home” in the Header line or by clicking on the AlphaDisc™ CLD logo in the upper left corner. The Home page contains the Sites List and Notification center.

The screenshot displays the AlphaDisc CLD Dashboard. The top header includes the logo, 'DASHBOARD', and user information 'Amir'. The left sidebar contains navigation menus for MONITORING (Sites, Sites Map, Alerts), SETTINGS (Sites Manager, System settings), and INFORMATION (Support, User Manual). The main content area is titled 'Sites' and lists five sites with their status and key metrics:

Site Name	Family	Status	Inlet Pressure (BAR)	DP Pressure (BAR)	Time from Last Flush	Last Flush Cause
Adi-x Beta 10 - Ginosar	Sk Family 2	Online	2.84	0.06	0h 5m	DP
Adi-x Beta 3 - Ramot Nova	Spinklin Nova Plus	Online	N/A	N/A	N/A	Manual
Wellington South Africa	Spinklin Nova	Online	0.17	0.06	N/A	None
Australia - Adix B-26	Sk Family 2	Online	N/A	N/A	N/A	Manual
Mexico - Adix B-25	Sigma Pro 6	Online	N/A	N/A	N/A	Manual

On the right side, the 'Notifications Center' shows four active alerts, all categorized as 'Low Downstream Pressure' for various sites: Spain - Adix B-32, Wellington South Africa, Mexico - Adix B-25, and USA - Adix B-22.

4.3.3.1.1 Sites List

Sites List contains all owned and linked Sites. Clicking on each element of the list will open the controller's Overview tab on Sites page, (see 4.3.3.2.3) Each list element contains the following information:

ELEMENT	DESCRIPTION
SITE PICTURE	SITE PICTURE UPLOADED BY SITE OWNER TO RECOGNIZE THE SITE.
COMMUNICATION STATUS	SMALL ICON ON THE SITE PICTURE REPRESENTS THE COMMUNICATION STATUS: BLUE ICON – THE CONTROLLER IS CONNECTED. GREY ICON – THE CONTROLLER IS DISCONNECTED.
SITE NAME	SITE NAME GIVEN BY SITE OWNER.
FILTER TYPE	FILTER(S) MODEL CONTROLLED BY THE CONTROLLER.
OPERATION MODE	CONTROLLER OPERATION MODE – PRIMARY OR SECONDARY.
POWER MODE	POWER MODE IS REPRESENTED BY THE ICON: PLUG – THE CONTROLLER IS ON AC POWER. BATTERY – THE CONTROLLER IS ON BATTERY POWER.
INFORMATION ICON	PLACE THE CURSOR ON THE INFORMATION ICON TO SEE THE FOLLOWING INFORMATION: <ul style="list-style-type: none"> • FW VERSION • HW VERSION • INSTALLATION DATE • TOTAL FLUSH COUNTER
ALERTS ICON	THE NUMBER ON THE ALERTS ICON REPRESENTS THE NUMBER OF ACTIVE ALERTS FOR THE SPECIFIC CONTROLLER. CLICK THE ALERTS ICON TO OPEN THE CONTROLLER'S ALERTS TAB ON SITES PAGE (SEE 4.3.3.2.6)
CONNECTION MODE	THE CONTROLLER CONNECTION MODE – ONLINE OR OFFLINE.
LAST CONNECTION	ONLY IN OFFLINE MODE. THE LAST TIME THE CONTROLLER WAS CONNECTED.
NEXT CONNECTION	ONLY IN OFFLINE MODE. THE TIME OF NEXT ATTEMPT TO CONNECT TO THE CONTROLLER.
LAST FLUSH DP AFTER	ONLY IN OFFLINE MODE. THE DP MEASURED AFTER FLUSHING. INTERVAL BETWEEN END OF FLUSHING AND DP MEASURING IS DETERMINED BY "IGNORE DP" PARAMETER (SEE APPENDIX A. ALPHADISC™ CLD CONTROLLER SETTINGS).
CONFIG SYNCED	ONLY IN OFFLINE MODE. INDICATES IF CONTROLLER CONFIGURATION IS UP TO DATE (LAST CHANGES SAVED) – YES OR NO.
INLET	THE CURRENT READING OF THE FILTER'S INLET PRESSURE.
DP	THE PRESSURE DIFFERENTIAL ACROSS THE FILTER; CALCULATED BY SUBTRACTING THE OUTLET PRESSURE FROM THE INLET PRESSURE.
TIME FROM LAST FLUSH	THE TIME SINCE THE END OF THE LAST FLUSH CYCLE.
LAST FLUSH CAUSE	THE TRIGGER THAT INITIATED THE LAST FLUSH.

4.3.3.1.2 Notifications center

ELEMENT	DESCRIPTION
DROPDOWN LIST	ALLOWS SELECTING WHICH NOTIFICATIONS ARE SHOWN – ALL / ALERTS / FLUSHES / INVITATIONS.
LIST OF NOTIFICATIONS	EACH ELEMENT OF THE LIST CONTAINS FOLLOWING INFORMATION: <ul style="list-style-type: none"> • NOTIFICATION TEXT • THE NAME OF CONTROLLER WHERE NOTIFICATION APPEARED

4.3.3.2 Sites Page

Sites page content area contains Sites List, Site Header and 7 tabs.

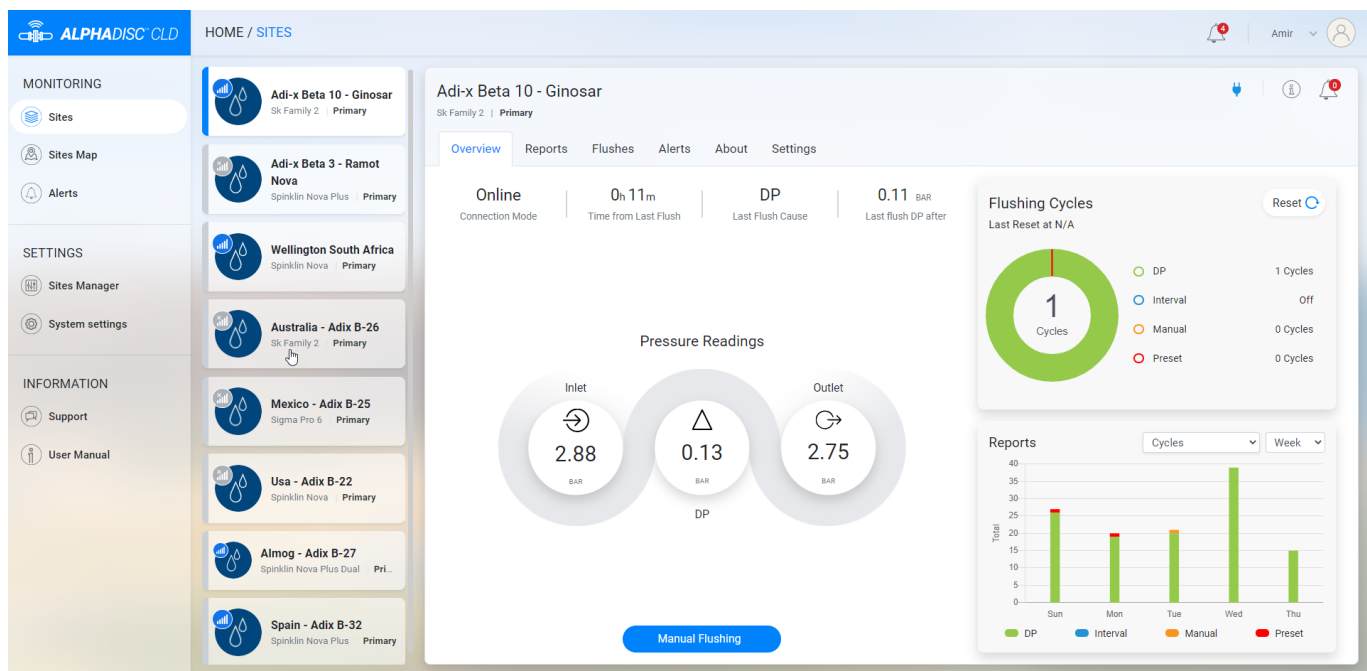

4.3.3.2.1 Sites List

Sites List is located at the left side of the screen. It contains all owned and linked Sites.

Each list element contains the following information:

ELEMENT	DESCRIPTION
SITE PICTURE	SITE PICTURE UPLOADED BY SITE OWNER TO RECOGNIZE THE SITE.
COMMUNICATION STATUS	SMALL ICON ON THE SITE PICTURE REPRESENTS THE COMMUNICATION STATUS: BLUE ICON – THE CONTROLLER IS CONNECTED. GREY ICON – THE CONTROLLER IS DISCONNECTED.
SITE NAME	SITE NAME GIVEN BY SITE OWNER.
FILTER TYPE	FILTER(S) MODEL CONTROLLED BY THE CONTROLLER.
OPERATION MODE	CONTROLLER OPERATION MODE – PRIMARY OR SECONDARY.

4.3.3.2.2 Site header

ELEMENT	DESCRIPTION
SITE NAME	SITE NAME GIVEN BY SITE OWNER.
FILTER TYPE	FILTER(S) MODEL CONTROLLED BY THE CONTROLLER.
OPERATION MODE	CONTROLLER OPERATION MODE – PRIMARY OR SECONDARY.
COMMUNICATION STATUS	IF THE CONTROLLER IS DISCONNECTED THE STATUS "DISCONNECTED" WILL BE SHOWN HERE IN RED.
POWER MODE	POWER MODE IS REPRESENTED BY THE ICON: PLUG – THE CONTROLLER IS ON AC POWER. BATTERY – THE CONTROLLER IS ON BATTERY POWER.
INFORMATION ICON	PLACE THE CURSOR ON INFORMATION ICON TO SEE THE FOLLOWING INFORMATION: <ul style="list-style-type: none"> • FW VERSION • HW VERSION • INSTALLATION DATE • TOTAL FLUSH COUNTER
ALERTS ICON	THE NUMBER ON THE ALERTS ICON REPRESENTS THE NUMBER OF ACTIVE ALERTS FOR THE SPECIFIC CONTROLLER.

4.3.3.2.3 Overview tab

ELEMENT	DESCRIPTION
CONNECTION MODE	THE CONTROLLER CONNECTION MODE – ONLINE OR OFFLINE.
LAST CONNECTION	ONLY IN OFFLINE MODE. THE LAST TIME THE CONTROLLER WAS CONNECTED.
NEXT CONNECTION	ONLY IN OFFLINE MODE. THE TIME OF NEXT ATTEMPT TO CONNECT TO THE CONTROLLER.
CONFIG SYNCED	ONLY IN OFFLINE MODE. INDICATES IF CONTROLLER CONFIGURATION IS UP TO DATE (LAST CHANGES SYNCHRONIZED WITH CONTROLLER) – YES OR NO.
TIME FROM LAST FLUSH	ONLY IN ONLINE MODE. THE TIME SINCE THE END OF THE LAST FLUSH CYCLE.
LAST FLUSH CAUSE	ONLY IN ONLINE MODE. THE TRIGGER THAT INITIATED THE LAST FLUSH.
LAST FLUSH DP AFTER	ONLY IN ONLINE MODE. THE DP MEASURED AFTER FLUSHING. INTERVAL BETWEEN END OF FLUSHING AND DP MEASURING IS DETERMINED BY "IGNORE DP" PARAMETER (SEE APPENDIX A. ALPHADISC™ CLD CONTROLLER SETTINGS).
PRESSURES READINGS – INLET	THE CURRENT READING OF THE FILTER'S INLET PRESSURE.
PRESSURES READINGS – OUTLET	THE CURRENT READING OF THE FILTER'S OUTLET PRESSURE.
PRESSURES READINGS – DP	THE PRESSURE DIFFERENTIAL ACROSS THE FILTER; CALCULATED BY SUBTRACTING THE OUTLET PRESSURE FROM THE INLET PRESSURE.
MANUAL FLUSHING BUTTON	ONLY IN ONLINE MODE. CLICK THIS BUTTON TO START A MANUAL FLUSH CYCLE.
FLUSHING CYCLES – DIAGRAM	DISPLAYS THE RATIO OF FLUSHING CYCLES STARTED DUE TO DIFFERENT CAUSES.
FLUSHING CYCLES – DP	THE NUMBER OF FLUSH CYCLES STARTED DUE TO A DP EVENT.
FLUSHING CYCLES – INTERVAL	THE NUMBER OF FLUSH CYCLES STARTED DUE TO THE TIME INTERVALS PROGRAM. ALSO COUNTS THE ANTIFREEZE PROTECTION INTERVALS FLUSHES.
FLUSHING CYCLES – MANUAL	THE NUMBER OF FLUSH CYCLES STARTED DUE TO A MANUAL FLUSH BY THE USER.
FLUSHING CYCLES – PRESET	THE NUMBER OF FLUSH CYCLES STARTED DUE TO THE PRESET START TIMES.
FLUSHING CYCLES – RESET BUTTON	CLICK THIS BUTTON TO RESET THE COUNTERS TO ZERO (EXCLUDING TOTAL FLUSH COUNTER).
REPORTS – DATA TYPE DROP-DOWN LIST	THE DROP-DOWN LIST FOR SELECTION OF DATA TYPE TO BE DISPLAYED ON THE CHART.
REPORTS – PERIOD DROP-DOWN LIST	THE DROP-DOWN LIST FOR SELECTION OF PERIOD FOR WHICH THE DATA WILL BE DISPLAYED ON THE CHART.
REPORTS – CHART	DISPLAYS THE DATA ACCORDING TO THE SELECTED PARAMETERS (DATA TYPE AND PERIOD).
LAST RESET DATE	THE DATE OF THE LAST RESETTING OF THE COUNTERS.

4.3.3.2.4 Reports tab

ELEMENT	DESCRIPTION
DATA TYPE DROP-DOWN LIST	THE DROP-DOWN LIST FOR SELECTION OF DATA TYPE TO BE DISPLAYED ON THE CHART.
TIME SPAN BUTTONS	CLICK DAY/WEEK/MONTH BUTTON TO SELECT DESIRED CHART'S TIME SPAN. BY DEFAULT, LAST WEEK EVENTS ARE SHOWN.
DATES SELECTION	ENABLES SHOWING EVENTS BETWEEN TWO DATES. SELECT THE DESIRED CHART'S TIME SPAN.
CHART	DISPLAYS THE DATA ACCORDING TO THE SELECTED PARAMETERS (DATA TYPE AND TIME SPAN).

4.3.3.2.5 Flushes tab

ELEMENT	DESCRIPTION
TIME SPAN BUTTONS	CLICK DAY/WEEK/MONTH BUTTON TO SELECT DESIRED LIST'S TIME SPAN. BY DEFAULT, LAST WEEK EVENTS ARE SHOWN.
DATES SELECTION	ENABLES SHOWING EVENTS BETWEEN TWO DATES. SELECT THE DESIRED LIST'S TIME SPAN.
LIST OF FLUSHES	<p>DISPLAY THE FLUSHES ACCORDING TO THEIR OCCURRENCE TIME AND DATE FOR SELECTED PERIOD. FOLLOWING INFORMATION FOR EVERY FLUSH IS SHOWN:</p> <ul style="list-style-type: none"> • FLUSH CAUSE • FLUSH DATE • FLUSH TIME • INLET PRESSURE BEFORE THE FLUSH • OUTLET PRESSURE BEFORE THE FLUSH • DP PRESSURE BEFORE THE FLUSH • DP PRESSURE AFTER (THE DP MEASURED AFTER FLUSHING. INTERVAL BETWEEN END OF FLUSHING AND DP MEASURING IS DETERMINED BY "IGNORE DP" PARAMETER).

4.3.3.2.6 Alerts tab

ELEMENT	DESCRIPTION
ACTIVE/HISTORY BUTTONS	<p>CLICK ACTIVE BUTTON TO SEE THE LIST OF ACTIVE ALERTS FOR THE SPECIFIC CONTROLLER.</p> <p>CLICK HISTORY BUTTON TO SEE THE LIST OF ALERT MESSAGES FOR THE SPECIFIC CONTROLLER ACCORDING TO THEIR OCCURRENCE TIME AND DATE.</p>
TIME SPAN BUTTONS	CLICK DAY/WEEK/MONTH BUTTON TO SELECT DESIRED LIST'S TIME SPAN. BY DEFAULT, LAST WEEK EVENTS ARE SHOWN.
DATES SELECTION	ENABLES SHOWING EVENTS BETWEEN TWO DATES. SELECT THE DESIRED LIST'S TIME SPAN.
ALERTS LIST	DISPLAY THE ACTIVE ALERTS OR THE LIST OF ALERT MESSAGES ACCORDING TO THEIR OCCURRENCE TIME AND DATE (ACTIVE/HISTORY TAB). SEE APPENDIX B. ALARMS AND FAULTS LIST.

4.3.3.2.7 About tab

About tab contains the following information:

- Device ID
- FW version
- HW version
- Installation Date
- Total Flush Counter

If any updates are available, notification is shown here.

4.3.3.2.8 Settings tab

This tab contains controller settings. See the list of settings with description in Appendix A. AlphaDisc™ CLD Controller Settings.

Click the setting to change it. Click **Save** to save changes.

4.3.3.3 Sites Map Page

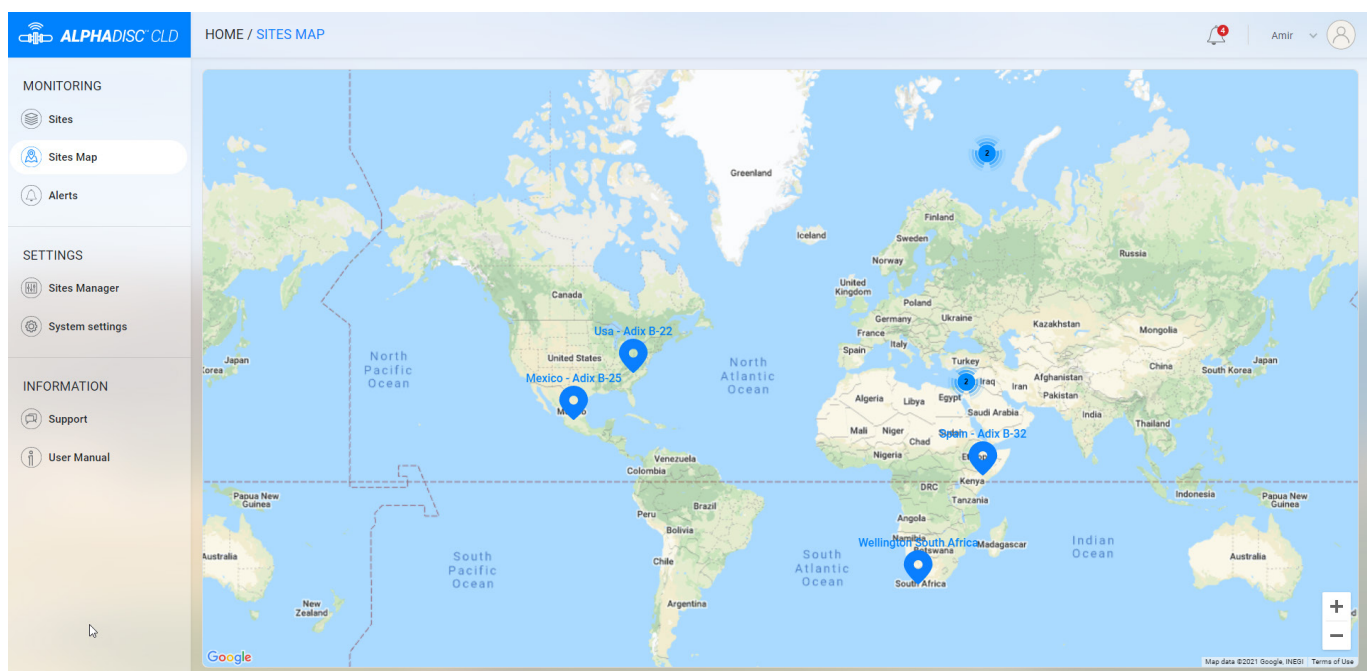

Sites Map page displays the map where all owned and linked Sites are marked. Use +/- buttons in bottom right corner or mouse wheel to zoom in/zoom out.

4.3.3.4 Alerts Page

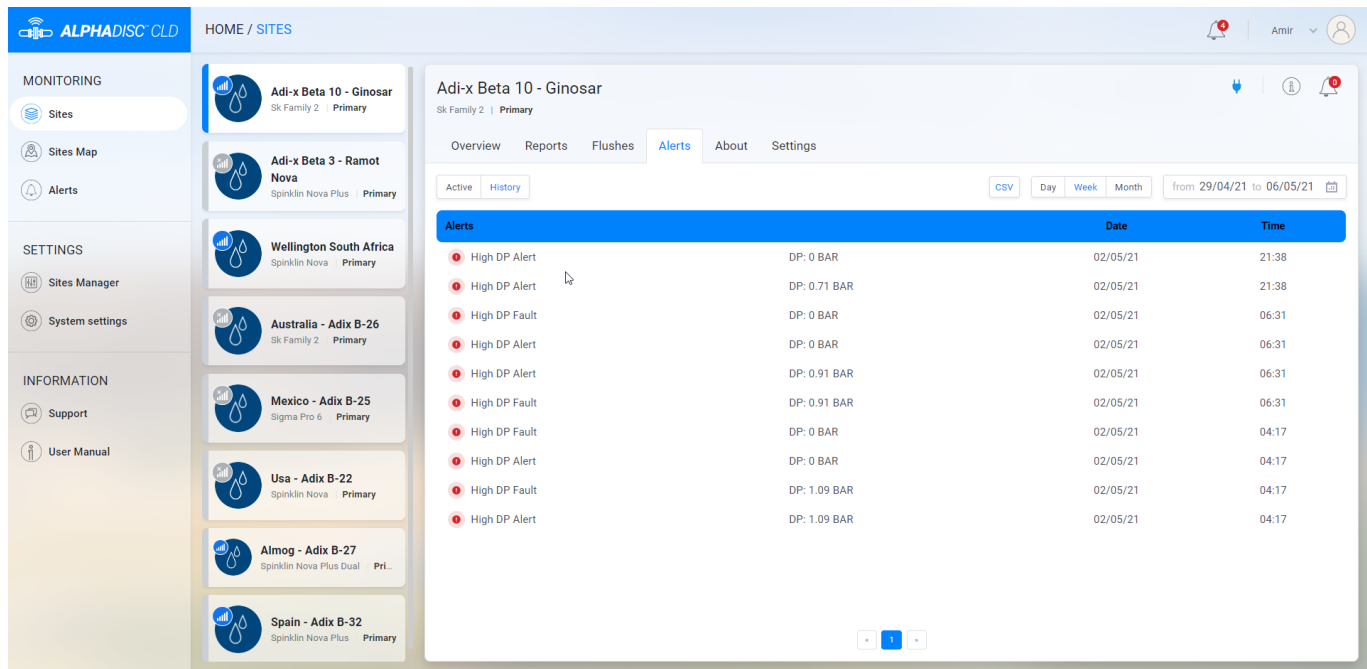

The Alerts page contains active alerts from **all connected controllers** and a list of alert messages according to their occurrence time and date.

The Alerts page contains the following elements:

ELEMENT	DESCRIPTION
ACTIVE/HISTORY BUTTONS	CLICK ACTIVE TO SEE THE LIST OF ACTIVE ALERTS FOR THE SPECIFIC CONTROLLER. CLICK HISTORY TO SEE THE LIST OF ALERT MESSAGES ACCORDING TO THEIR OCCURRENCE TIME AND DATE.
TIME SPAN BUTTONS	AVAILABLE ONLY ON HISTORY TAB. CLICK DAY/WEEK/MONTH BUTTON TO SELECT DESIRED LIST'S TIME SPAN. BY DEFAULT, LAST WEEK EVENTS ARE SHOWN.
DATES SELECTION	AVAILABLE ONLY ON HISTORY TAB. ENABLES SHOWING EVENTS BETWEEN TWO DATES. SELECT THE DESIRED LIST'S TIME SPAN.
ALERTS LIST	DISPLAY THE ACTIVE ALERTS OR THE LIST OF ALERT MESSAGES ACCORDING TO THEIR OCCURRENCE TIME AND DATE (ACTIVE/HISTORY TAB). SEE APPENDIX B. ALARMS AND FAULTS LIST.
PAGE NAVIGATION	USE ARROWS IN BOTTOM LEFT CORNER TO SWITCH BETWEEN PAGES.
LINES PER VIEW	USE DROP-DOWN LIST IN BOTTOM RIGHT CORNER TO CHOOSE HOW MANY LINES WILL BE DISPLAYED ON ONE PAGE.

4.3.3.5 Sites Manager Page

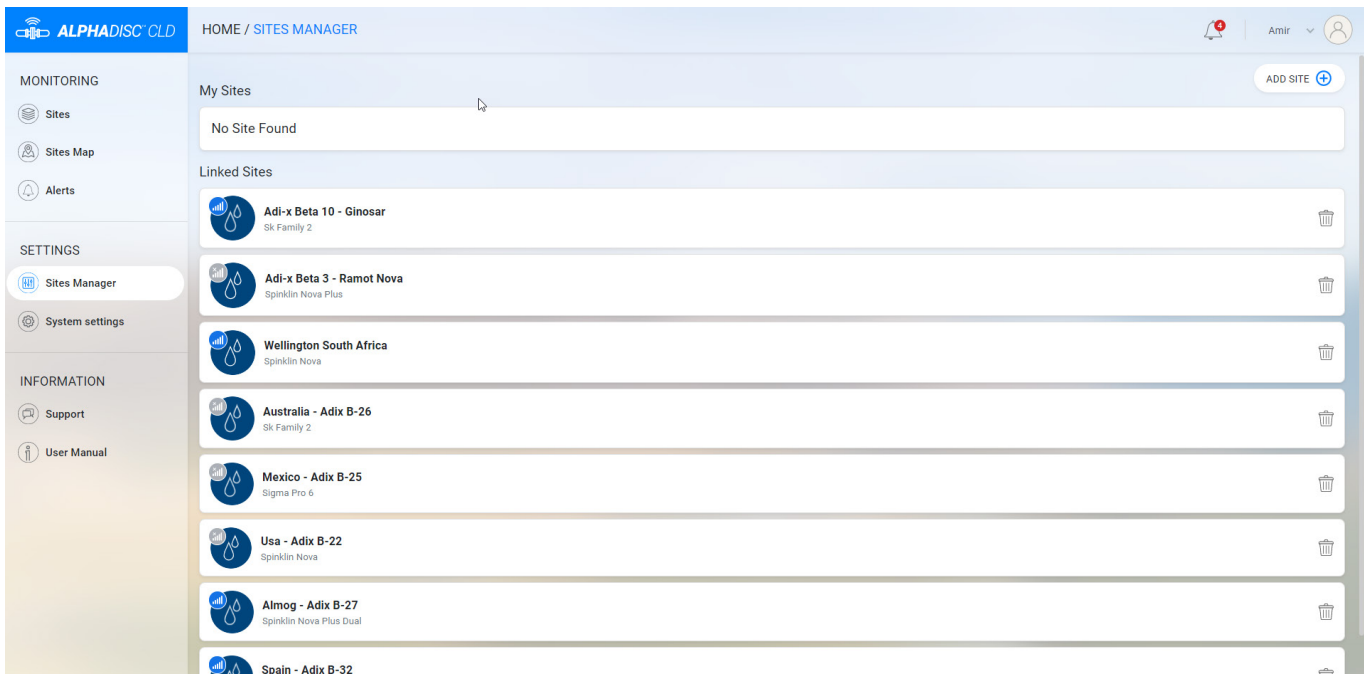

Sites Manager page allows adding, editing, and deleting sites from the account. It contains the following elements:

ELEMENT	DESCRIPTION
ADD SITE BUTTON	CLICK THIS BUTTON TO START PAIRING WITH A NEW CONTROLLER.
MY SITES LIST	LIST OF OWNED SITES. EACH ELEMENT OF THE LIST CONTAINS THE FOLLOWING INFORMATION: <ul style="list-style-type: none"> • SITE PICTURE • COMMUNICATION STATUS ICON • SITE NAME • FILTER TYPE • INVITE ICON – CLICK TO SHARE THE SITE WITH OTHER ACCOUNT • EDIT ICON – CLICK TO EDIT SITE ID, INFORMATION, LOCATION, AND MANAGE INVITATIONS • DELETE ICON – CLICK THIS ICON TO DELETE THE SITE FROM THE ACCOUNT
LINKED SITES LIST	LIST OF LINKED SITES. EACH ELEMENT OF THE LIST CONTAINS THE FOLLOWING INFORMATION: <ul style="list-style-type: none"> • SITE PICTURE • COMMUNICATION STATUS ICON • SITE NAME • FILTER TYPE • DELETE ICON – CLICK THIS ICON TO DELETE THE SITE FROM THE ACCOUNT.

4.3.3.6 System Settings Page

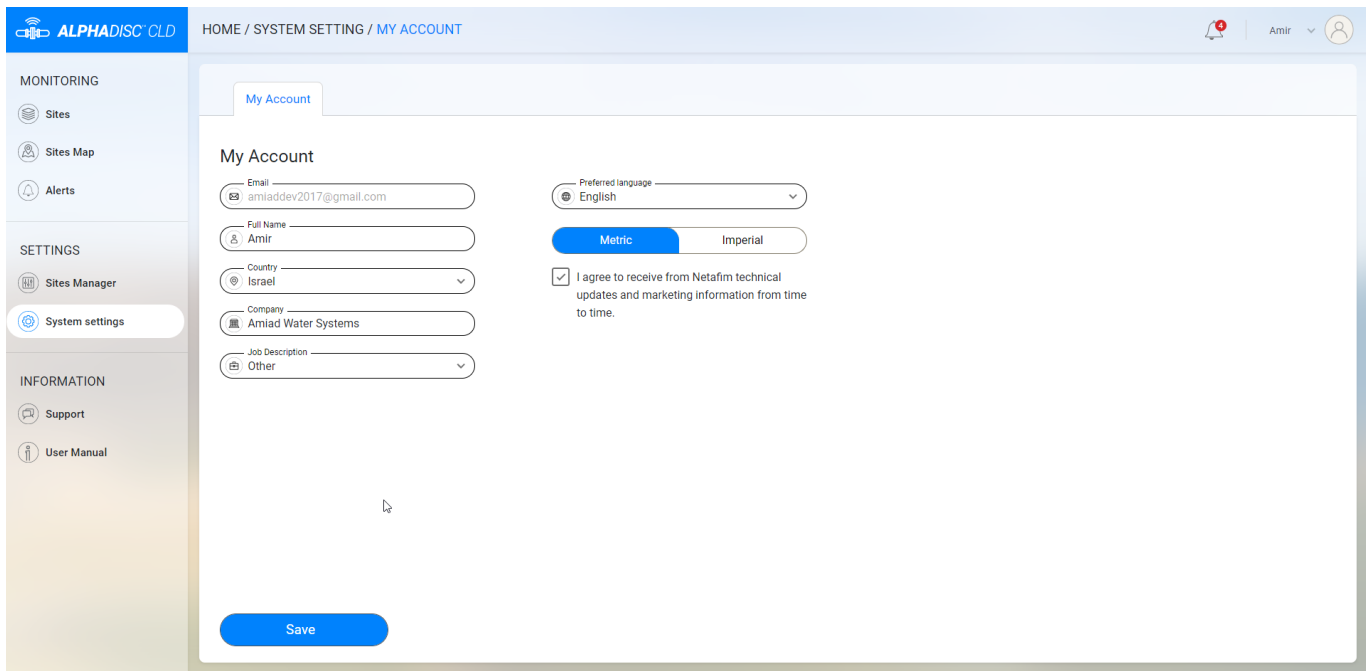

System settings page contains two tabs: My Account and Change Password. See details in the following tables:

4.3.3.6.1 My Account tab

ELEMENT	DESCRIPTION
EMAIL	THE EMAIL ADDRESS YOU ENTERED WHILE CREATING AN ACCOUNT. CANNOT BE CHANGED.
FULL NAME	USER'S FULL NAME.
COUNTRY	COUNTRY OF OPERATION (DROP-DOWN LIST).
COMPANY	USER'S COMPANY NAME.
JOB DESCRIPTION	USER'S JOB DESCRIPTION (DROP-DOWN LIST).
PREFERRED LANGUAGE	THE LANGUAGE OF APPLICATIONS (DROP-DOWN LIST).
UNITS SELECTION	UNITS TO BE USED IN APPLICATIONS.
RECEIVE UPDATES FROM NETAFIM	CHECK THIS CHECKBOX TO RECEIVE UPDATES FROM NETAFIM.
SAVE BUTTON	CLICK SAVE TO SAVE ANY CHANGES.

4.3.3.7 Support Pop-Up Window

Need Help?
Send us a Message

Full Name Amir

Email amiaddev2017@gmail.com

Company Amiad Water Systems

SEND

v 1.2.8

Support Pop-Up Window allows sending messages to Netafim support. It contains the following elements:

ELEMENT	DESCRIPTION
FULL NAME	YOUR FULL NAME
EMAIL	YOUR EMAIL
COMPANY	YOUR COMPANY NAME
MESSAGE FIELD	WRITE YOUR MESSAGE TO NETAFIM SUPPORT HERE.
SEND BUTTON	CLICK SEND TO SEND YOUR MESSAGE TO NETAFIM SUPPORT.

4.3.3.8 User Manual Page

The User manual page contains the link to the digital version of the User Manual.

4.4 GETTING TO KNOW THE ALPHADISC™ CLD MOBILE APPLICATION

Take a few moments to familiarize yourself with the AlphaDisc™ CLD Mobile Application interface. AlphaDisc™ CLD mobile application has eight main screens. Every application screen has a Header line containing the Menu button and screen name. You can switch between the app screens using the Menu button. See details in the following tables.

4.4.1 Header Line Details

ELEMENT	DESCRIPTION
MENU BUTTON	OPENS THE MENU TO SWITCH BETWEEN SCREENS.
SCREEN NAME	THE NAME OF THE CURRENT SCREEN.

4.4.2 Menu Details

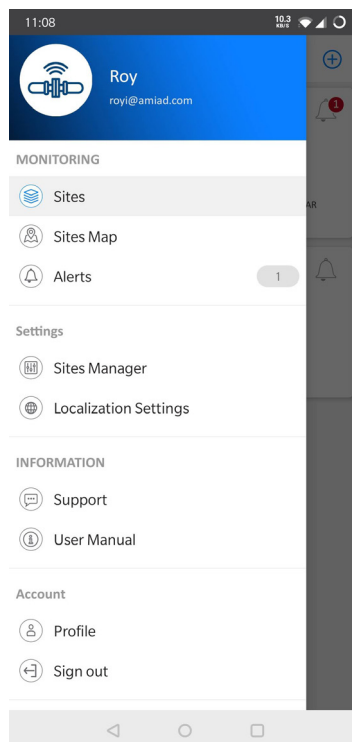

ELEMENT	DESCRIPTION
UPPER RED AREA	CONTAINS USER NAME AND ACCOUNT EMAIL.
MONITORING SITES	OPENS SITES SCREEN. THE SITES SCREEN CONTAINS THE LIST OF ALL OWNED AND LINKED SITES AS WELL AS SITES OVERVIEW AND SETTINGS, AND ADD SITE BUTTON. SEE 4.4.3.1.
MONITORING SITES MAP	OPENS SITES MAP SCREEN. THE SITES MAP SCREEN CONTAINS THE MAP WHERE ALL OWNED AND LINKED SITES ARE MARKED, AS WELL AS ADD SITE BUTTON. SEE 4.4.3.2.
MONITORING ALERTS	OPENS ALERTS SCREEN. THE ALERTS SCREEN CONTAINS ACTIVE ALERTS FROM ALL CONNECTED CONTROLLERS AND A LIST OF ALERT MESSAGES ACCORDING TO THEIR OCCURRENCE TIME AND DATE. SEE 4.4.3.3.
SETTINGS SITES MANAGER	OPENS SITES MANAGER SCREEN. THE SITES MANAGER SCREEN CONTAINS A LIST OF ALL OWNED AND LINKED SITES, AS WELL AS ADD SITE BUTTON. SEE 4.4.3.4.
SETTINGS LOCALIZATION SETTINGS	OPENS LOCALIZATION SETTINGS SCREEN THE LOCALIZATION SETTINGS SCREEN CONTAINS LOCALIZATION PARAMETERS – LANGUAGE AND UNITS. SEE 4.4.3.5.
INFORMATION SUPPORT	OPENS SUPPORT MESSAGE CENTER. SEE 4.4.3.6.
INFORMATION USER MANUAL	OPENS USER MANUAL SCREEN, CONTAINING A LINK TO THE DIGITAL VERSION OF THE USER MANUAL. SEE 4.4.3.7.
ACCOUNT PROFILE	OPENS PROFILE SCREEN. THE PROFILE SCREEN CONTAINS ACCOUNT PARAMETERS. SEE 4.4.3.8.
ACCOUNT SIGN OUT	CLICK IT TO SIGN OUT OF THE ACCOUNT.

4.4.3 Screens Details

4.4.3.1 Sites Screen

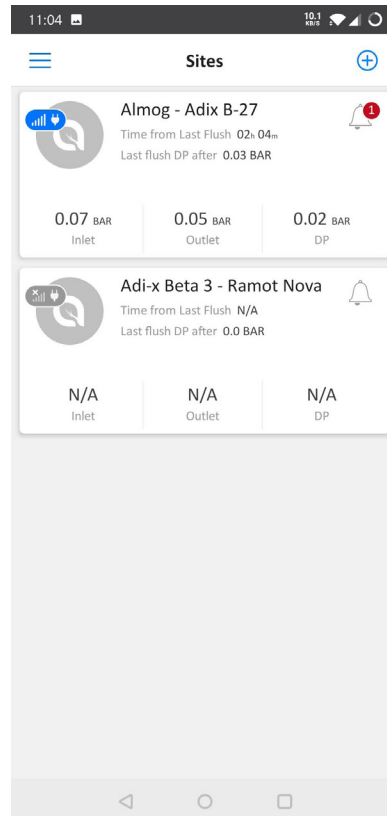

Sites screen contains all owned and linked Sites List. The **Add Site** button is located in the upper right corner. Each list element contains the following information:

ELEMENT	DESCRIPTION
SITE PICTURE	SITE PICTURE UPLOADED BY SITE OWNER TO RECOGNIZE THE SITE.
COMMUNICATION STATUS	SMALL ICON ON THE SITE PICTURE REPRESENTS THE COMMUNICATION STATUS: BLUE ICON – THE CONTROLLER IS CONNECTED. GREY ICON – THE CONTROLLER IS DISCONNECTED.
POWER MODE	SMALL ICON ON THE SITE PICTURE REPRESENTS THE POWER MODE: PLUG – THE CONTROLLER IS ON AC POWER. BATTERY – THE CONTROLLER IS ON BATTERY POWER.
SITE NAME	SITE NAME GIVEN BY SITE OWNER.
TIME FROM LAST FLUSH	ONLY IN ONLINE MODE. THE TIME SINCE THE END OF THE LAST FLUSH CYCLE.
LAST FLUSH DP AFTER	ONLY IN ONLINE MODE. THE DP MEASURED AFTER FLUSHING. INTERVAL BETWEEN END OF FLUSHING AND DP MEASURING IS DETERMINED BY "IGNORE DP" PARAMETER (SEE APPENDIX A. ALPHADISC™ CLD CONTROLLER SETTINGS).
LAST RECEIVED INLET	ONLY IN OFFLINE MODE. LAST INLET PRESSURE RECEIVED WHEN CONNECTED.
LAST RECEIVED DP	ONLY IN OFFLINE MODE. LAST DP RECEIVED WHEN CONNECTED.
ALERTS ICON	THE NUMBER ON ALERTS ICON REPRESENTS THE NUMBER OF ACTIVE ALERTS FOR THE SPECIFIC CONTROLLER. CLICK THE ALERTS ICON TO OPEN ALERTS TAB OF THE SITE.
INLET	ONLY IN ONLINE MODE. THE CURRENT READING OF THE FILTER'S INLET PRESSURE.
OUTLET	ONLY IN ONLINE MODE. THE CURRENT READING OF THE FILTER'S OUTLET PRESSURE.
DP	ONLY IN ONLINE MODE. THE PRESSURE DIFFERENTIAL ACROSS THE FILTER; CALCULATED BY SUBTRACTING THE OUTLET PRESSURE FROM THE INLET PRESSURE.
LAST CONNECTION	ONLY IN OFFLINE MODE. THE LAST TIME THE CONTROLLER WAS CONNECTED.
NEXT CONNECTION	ONLY IN OFFLINE MODE. THE TIME OF NEXT ATTEMPT TO CONNECT TO THE CONTROLLER.
CONF. PARAMS	ONLY IN OFFLINE MODE. INDICATES IF CONTROLLER CONFIGURATION IS UP TO DATE (LAST CHANGES SYNCHRONIZED WITH CONTROLLER) – SYNCED / NOT SYNCED

Click on Site name to open Site details. There are 5 tabs and Settings menu for each Site.
 Scroll through these tabs by swiping to the right or to the left or by clicking on the designated icons that appear at the bottom of the screen.

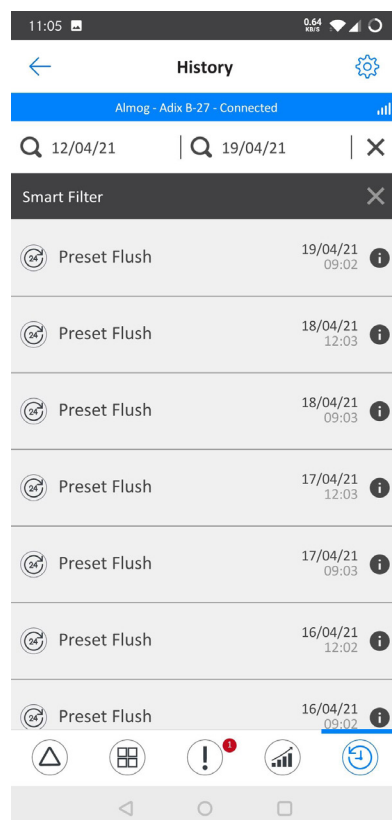
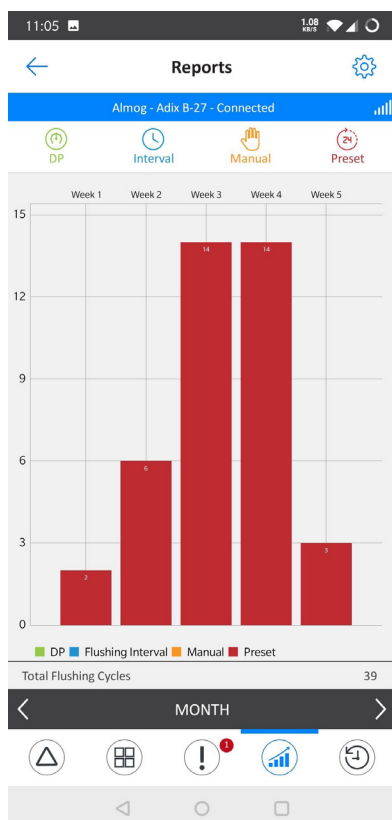
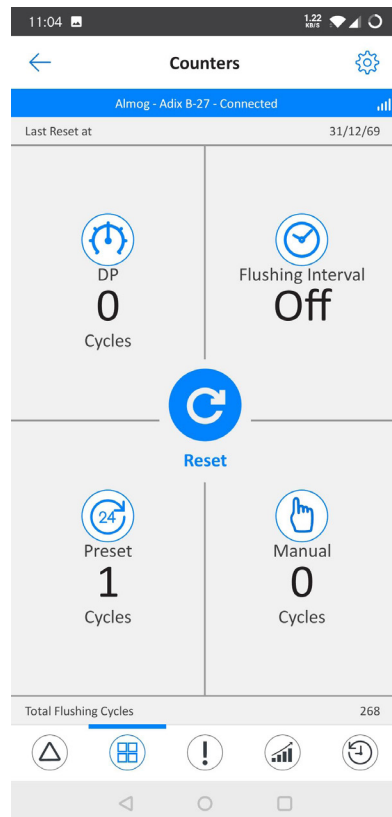
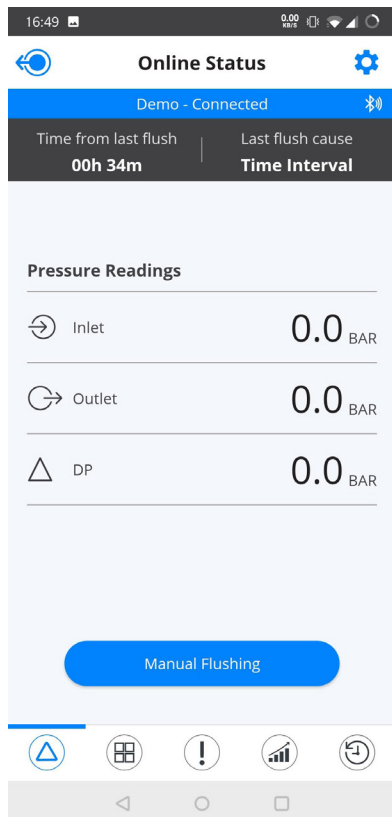

4.4.3.1.1 Online status tab

ELEMENT	DESCRIPTION
THE UPPER RED / GREY LINE	DISPLAYS THE NAME OF THE SITE AND THE COMMUNICATION STATUS: CONNECTED / DISCONNECTED.
LAST CONNECTION	ONLY IN OFFLINE MODE. THE LAST TIME THE CONTROLLER WAS CONNECTED.
NEXT CONNECTION	ONLY IN OFFLINE MODE. THE TIME OF NEXT ATTEMPT TO CONNECT TO THE CONTROLLER.
TIME FROM LAST FLUSH	ONLY IN ONLINE MODE. THE TIME SINCE THE END OF THE LAST FLUSH CYCLE.
LAST FLUSH CAUSE	ONLY IN ONLINE MODE. THE TRIGGER THAT INITIATED THE LAST FLUSH.
PRESSURES – INLET	THE CURRENT READING OF THE FILTER'S INLET PRESSURE.
PRESSURES – OUTLET	THE CURRENT READING OF THE FILTER'S OUTLET PRESSURE.
PRESSURES – DP	THE PRESSURE DIFFERENTIAL ACROSS THE FILTER; CALCULATED BY SUBTRACTING THE OUTLET PRESSURE FROM THE INLET PRESSURE.
MANUAL FLUSHING BUTTON	ONLY IN ONLINE MODE. CLICK THIS BUTTON TO START A MANUAL FLUSH CYCLE.

4.4.3.1.2 Counters tab

ELEMENT	DESCRIPTION
THE UPPER RED/GREY LINE	DISPLAYS THE NAME OF THE SITE AND THE COMMUNICATION STATUS. CONNECTED / DISCONNECTED.
LAST RESET AT:	THE DATE OF THE LAST RESETTING OF THE COUNTERS.
DP CYCLES	THE NUMBER OF FLUSH CYCLES STARTED DUE TO A DP SIGNAL.
FLUSHING INTERVAL CYCLES	THE NUMBER OF FLUSH CYCLES STARTED DUE TO THE TIME INTERVALS PROGRAM. ALSO COUNTS THE ANTIFREEZE PROTECTION INTERVALS FLUSHES.
PRESET CYCLES	THE NUMBER OF FLUSH CYCLES STARTED DUE TO THE PRESET START TIMES.
MANUAL CYCLES	THE NUMBER OF FLUSH CYCLES STARTED DUE TO A MANUAL START COMMAND ISSUED BY THE USER.
TOTAL FLUSHING CYCLES	THE TOTAL NUMBER OF FLUSH CYCLES STARTED FOR ANY REASON.
RESET BUTTON	CLICK THIS BUTTON TO RESET THE COUNTERS TO ZERO (EXCLUDING TOTAL FLUSHING COUNTER).

4.4.3.1.3 Alerts tab

ELEMENT	DESCRIPTION
THE UPPER RED/GREY LINE	DISPLAYS THE NAME OF THE SITE AND THE COMMUNICATION STATUS. CONNECTED / DISCONNECTED.
ACTIVE/HISTORY BUTTONS	CLICK ACTIVE BUTTON TO SEE THE LIST OF ACTIVE ALERTS FOR THE SPECIFIC CONTROLLER. CLICK HISTORY BUTTON TO SEE THE LIST OF ALERT MESSAGES FOR THE SPECIFIC CONTROLLER ACCORDING TO THEIR OCCURRENCE TIME AND DATE.
DATES SELECTION	AVAILABLE ONLY ON HISTORY TAB. ENABLES SHOWING EVENTS BETWEEN TWO DATES. THE ALERT MESSAGES FOR SELECTED TIME SPAN WILL BE DISPLAYED IN THE LIST.
ALERTS LIST	DISPLAY THE ACTIVE ALERTS OR THE LIST OF ALERT MESSAGES ACCORDING TO THEIR OCCURRENCE TIME AND DATE (ACTIVE/HISTORY TAB). SEE APPENDIX B. ALARMS AND FAULTS LIST.

4.4.3.1.4 Reports tab

ELEMENT	DESCRIPTION
THE UPPER RED/GREY LINE	DISPLAYS THE NAME OF THE SITE AND THE COMMUNICATION STATUS. CONNECTED / DISCONNECTED.
THE SECOND LINE	DISPLAYS ICONS OF THE DIFFERENT FLUSH TYPES. SELECT THE DESIRED ICONS TO BE DISPLAYED ON THE CHART.
THE CHART WINDOW	DISPLAYS THE NUMBER OF FLUSH CYCLES ACCORDING TO THE SELECTED ICONS.
TOTAL FLUSHING CYCLES	THE TOTAL NUMBER OF FLUSH CYCLES CURRENTLY DISPLAYED IN THE CHART WINDOW.
THE LOWER BLACK LINE	ENABLES THE USER TO SELECT THE CHART'S TIME SPAN (DAY, WEEK, MONTH).

4.4.3.1.5 History tab

ELEMENT	DESCRIPTION
THE UPPER RED/GREY LINE	DISPLAYS THE NAME OF THE SITE AND THE COMMUNICATION STATUS. CONNECTED / DISCONNECTED.
THE SECOND LINE	ENABLES SHOWING EVENTS BETWEEN TWO DATES.
SMART FILTER	ENABLES FILTERING EVENTS ACCORDING TO THE FOUR FLUSH TYPES (FLUSHING INTERVAL, DP, MANUAL, PRESET).
THE EVENTS LIST	DISPLAYS THE EVENTS MESSAGES ACCORDING TO THEIR OCCURRENCE TIME AND DATE. FLUSH CAUSE, FLUSH DATE, AND FLUSH TIME ARE SHOWN IN EVERY ROW OF THE LIST. CLICK  ICON TO SEE THE FOLLOWING INFORMATION: <ul style="list-style-type: none"> • INLET PRESSURE BEFORE THE FLUSH • OUTLET PRESSURE BEFORE THE FLUSH • DP PRESSURE BEFORE THE FLUSH • DP PRESSURE AFTER (THE DP MEASURED AFTER FLUSHING. INTERVAL BETWEEN END OF FLUSHING AND DP MEASURING IS DETERMINED BY "IGNORE DP" PARAMETER).

4.4.3.1.6 Settings menu

Enter the Settings menu by clicking on the  icon in the upper right corner of any of the 5 tabs. This menu contains controller settings. See the list of settings with description in Appendix A. AlphaDisc™ CLD Controller Settings. Click the setting to change it. Click **Save** to save changes.

4.4.3.2 Sites Map Screen

Sites Map screen displays the map where all owned and linked Sites are marked. The Add Site button is located in the upper right corner.



4.4.3.3 Alerts Screen

The Alerts screen contains active alerts from all connected controllers and a list of alert messages according to their occurrence time and date.



The Alerts screen contains the following elements:

ELEMENT	DESCRIPTION
ACTIVE/HISTORY TABS	CLICK ACTIVE TO SEE THE LIST OF ACTIVE ALERTS FOR THE SPECIFIC CONTROLLER. CLICK HISTORY TO SEE THE LIST OF ALERT MESSAGES ACCORDING TO THEIR OCCURRENCE TIME AND DATE.
DATES SELECTION	AVAILABLE ONLY ON HISTORY TAB. ENABLES SHOWING EVENTS BETWEEN TWO DATES. SELECT THE DESIRED LIST'S TIME SPAN.
FILTER BY SITE	ENABLES FILTERING EVENTS ACCORDING TO THE SITE NAME.
ALERTS LIST	DISPLAYS THE ACTIVE ALERTS OR THE LIST OF ALERT MESSAGES ACCORDING TO THEIR OCCURRENCE TIME AND DATE (ACTIVE / HISTORY TAB). SEE APPENDIX B. ALARMS AND FAULTS LIST.

4.4.3.4 Sites Manager Screen

Sites Manager screen allows adding and deleting sites from the account. The Add Site button is located in the upper right corner.

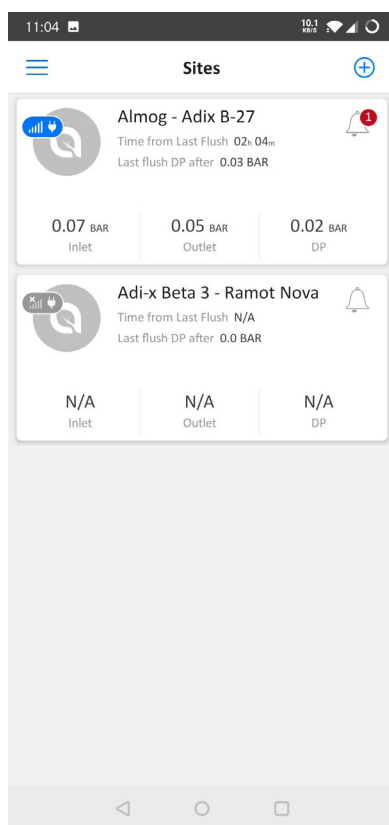

The Site Manager screen contains the following elements:

ELEMENT	DESCRIPTION
MY SITES LIST	LIST OF OWNED SITES. EACH ELEMENT OF THE LIST CONTAINS THE FOLLOWING INFORMATION: <ul style="list-style-type: none"> • SITE PICTURE • COMMUNICATION STATUS ICON • POWER MODE ICON • SITE NAME • DELETE ICON – CLICK THIS ICON TO DELETE THE SITE FROM THE ACCOUNT • EDIT ICON – CLICK THIS ICON TO EDIT SITE INFORMATION • INVITE ICON – CLICK THIS ICON TO SEE LIST OF INVITATIONS AND SEND NEW INVITATION.
LINKED SITES LIST	LIST OF LINKED SITES. EACH ELEMENT OF THE LIST CONTAINS THE FOLLOWING INFORMATION: <ul style="list-style-type: none"> • SITE PICTURE • COMMUNICATION STATUS ICON • POWER MODE ICON • SITE NAME • SITE OWNER EMAIL • DELETE ICON – CLICK THIS ICON TO DELETE THE SITE FROM THE ACCOUNT.

4.4.3.5 System Settings Screen

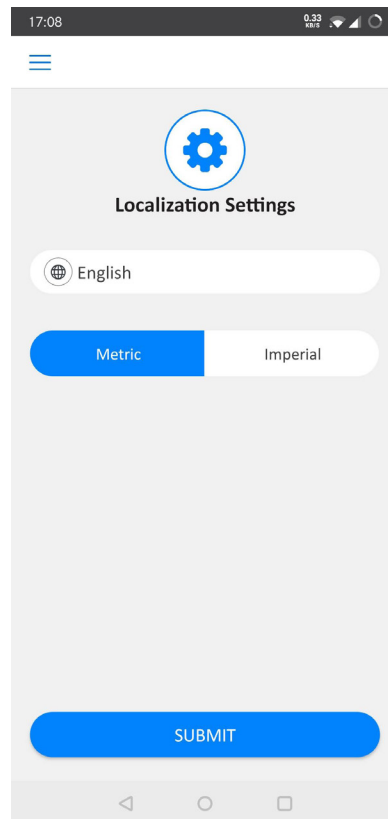

System settings screen allows changing the user settings preferences:

ELEMENT	DESCRIPTION
PREFERRED LANGUAGE	THE LANGUAGE OF APPLICATIONS.
UNITS SELECTION	UNITS TO BE USED IN APPLICATIONS.
SUBMIT BUTTON	CLICK SUBMIT TO SAVE ANY CHANGES.

4.4.3.6 Support Screen

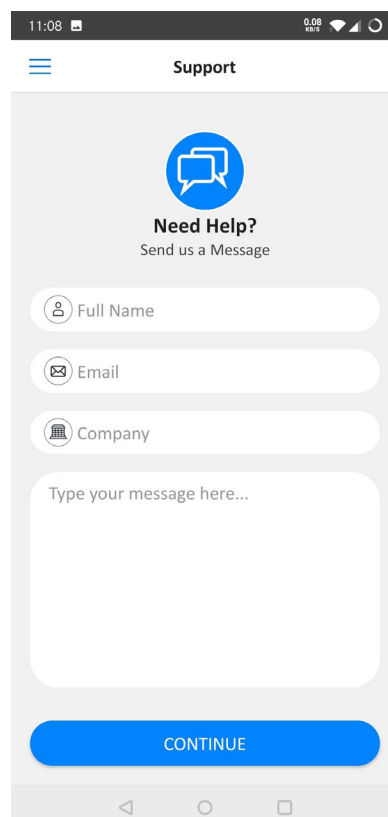

Support Screen allows sending messages to Netafim support. It contains the following elements:

ELEMENT	DESCRIPTION
FULL NAME	YOUR FULL NAME
EMAIL	YOUR EMAIL
COMPANY	YOUR COMPANY NAME
MESSAGE FIELD	WRITE YOUR MESSAGE TO NETAFIM SUPPORT HERE.
SUBMIT BUTTON	CLICK SUBMIT TO SEND YOUR MESSAGE TO NETAFIM SUPPORT.

4.4.3.7 User Manual Screen

The User manual screen contains the link to the digital version of the User Manual.

4.4.3.8 Profile Screen

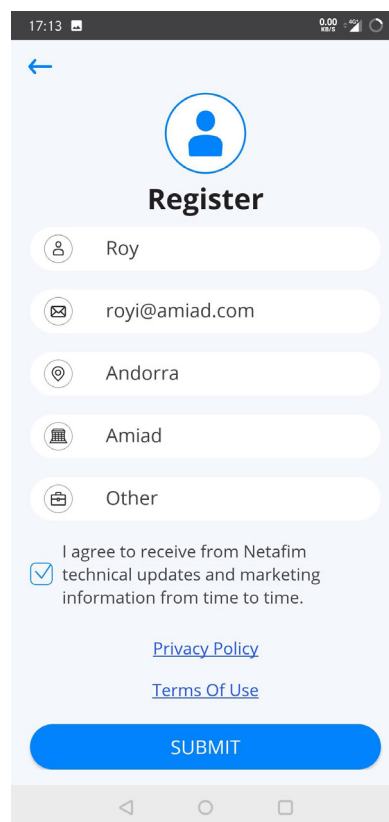

Profile screen allows changing account parameters:

ELEMENT	DESCRIPTION
FULL NAME	USER'S FULL NAME.
COUNTRY	COUNTRY OF OPERATION (DROP-DOWN LIST).
COMPANY	USER'S COMPANY NAME.
JOB DESCRIPTION	USER'S JOB DESCRIPTION (DROP-DOWN LIST).
RECEIVE UPDATES FROM NETAFIM	CHECK THIS CHECKBOX TO RECEIVE UPDATES FROM NETAFIM.
SUBMIT BUTTON	CLICK SUBMIT TO SAVE ANY CHANGES DONE.

4.5 GETTING TO KNOW THE ALPHADISC™ BLE MOBILE APPLICATION

Take a few moments to familiarize yourself with the AlphaDisc™ BLE Mobile Application interface.

AlphaDisc™ BLE Mobile application consists of Sites List screen, containing the list of all paired controllers, Menu screen, and Site tabs that are available for each active site. See details in the following tables.

4.5.1 Screens Details

4.5.1.1 Sites List Screen

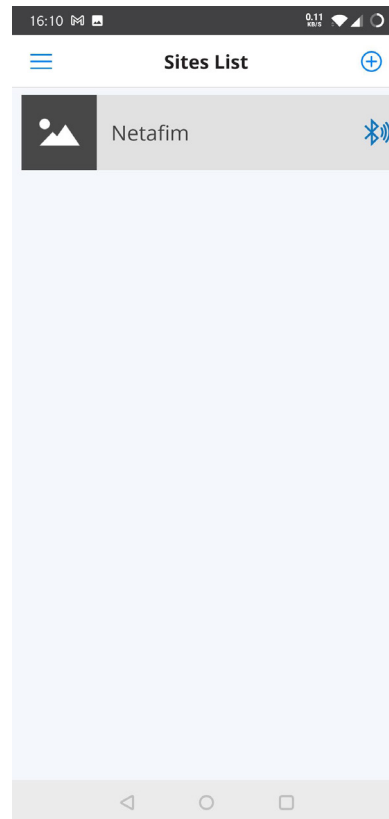

ELEMENT	DESCRIPTION
MENU BUTTON	OPENS MENU SCREEN (SEE 4.5.1.2)
ADD NEW SITE BUTTON	STARTS PAIRING PROCESS FOR NEW SITE.
LIST OF PAIRED SITES	LIST OF ALL PAIRED SITES. CLICKING ON ACTIVE SITE WILL OPEN SITE TABS (SEE 4.5.1.3). EACH ELEMENT OF THE LIST CONTAINS FOLLOWING INFORMATION: <ul style="list-style-type: none">• SITE PICTURE• SITE NAME• BLUETOOTH® ICON – BLUE WHEN AVAILABLE AND GREY WHEN OUT OF RANGE

4.5.1.2 Menu Screen

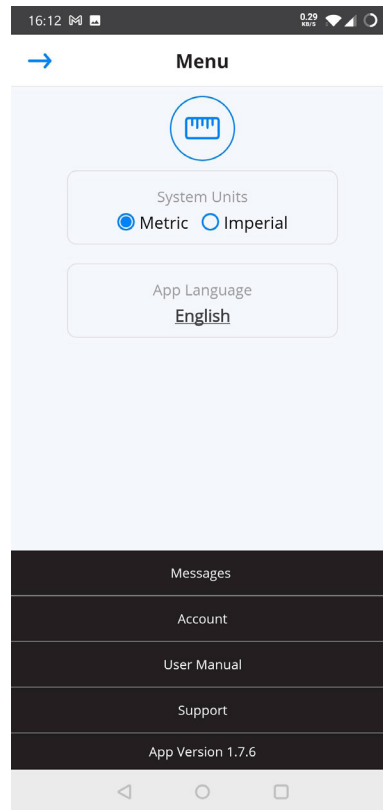

Enter the menu screens by clicking on the Menu icon in the upper left corner of the Site List screen:

ELEMENT	DESCRIPTION
SYSTEM UNITS	SELECT THE SYSTEM ENGINEERING UNITS: METRIC OR US.
LANGUAGE	SELECT THE APPLICATION USER INTERFACE LANGUAGE: ENGLISH, FRENCH, GERMAN, HEBREW, ITALIAN, SPANISH, PORTUGUESE, CHINESE, RUSSIAN, OR TURKISH.
MESSAGES	MESSAGES FROM THE NETAFIM SYSTEM.
ACCOUNT	DISPLAYS THE REGISTRATION DETAILS OF THE SYSTEM: USER NAME, USER EMAIL, USER COUNTRY, USER COMPANY AND USER JOB DESCRIPTION.
USER MANUAL	THIS SCREEN SHOWS THE USER MANUAL.
SUPPORT	CONTACT US SCREEN.
APP VERSION	DISPLAYS THE CURRENT VERSION OF THE ALPHADISC™ BLE APPLICATION.

4.5.1.3 Site Tabs

Once selecting the Site to interface the filter, the application has 5 tabs.

Scroll through these tabs by swiping to the right or to the left. You may also reach the desired tab by clicking on the designated icons that appear at the bottom of the screen.

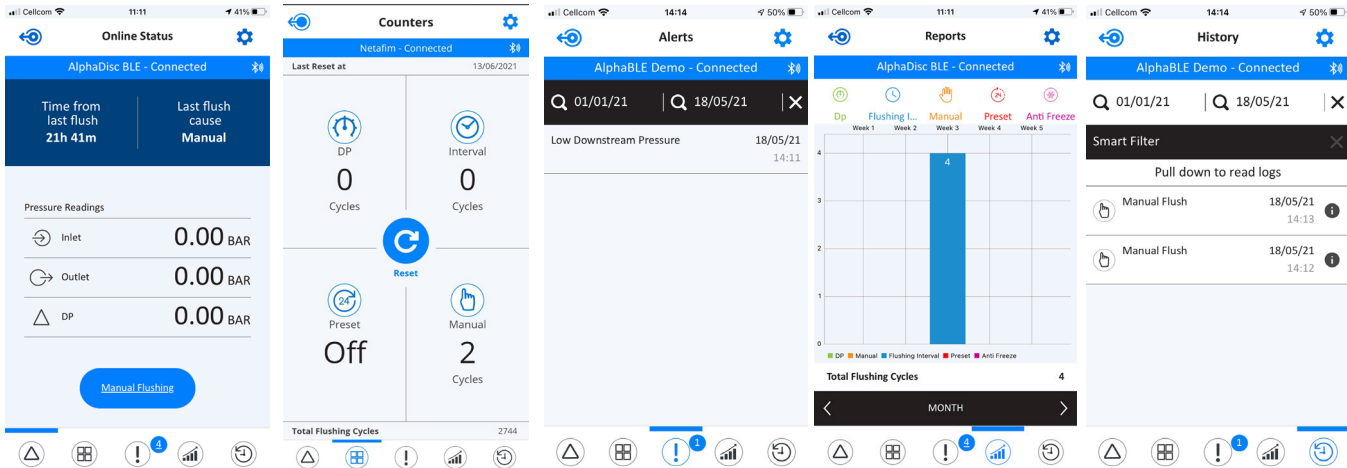

4.5.1.3.1 The Online Status Tab

ELEMENT	DESCRIPTION
THE UPPER RED / GREY LINE	DISPLAYS THE NAME OF THE CURRENTLY CONNECTED CONTROLLER AND THE COMMUNICATION STATUS (CONNECTED / DISCONNECTED).
TIME FROM LAST FLUSH	THE TIME SINCE THE END OF THE LAST FLUSH CYCLE.
LAST FLUSH CAUSE	THE TRIGGER THAT INITIATED THE LAST FLUSH.
PRESSURES - INLET	THE CURRENT READING OF THE FILTER'S INLET PRESSURE.
PRESSURE - OUTLET	THE CURRENT READING OF THE FILTER'S OUTLET PRESSURE.
PRESSURE - DP	THE PRESSURE DIFFERENTIAL ACROSS THE FILTER; CALCULATED BY SUBTRACTING THE OUTLET PRESSURE FROM THE INLET PRESSURE.
MANUAL FLUSHING	CLICK THIS ICON TO START A MANUAL FLUSH CYCLE.

4.5.1.3.2 The Counters Tab

ELEMENT	DESCRIPTION
THE UPPER RED / GREY LINE	DISPLAYS THE NAME OF THE CURRENTLY CONNECTED CONTROLLER AND THE COMMUNICATION STATUS (CONNECTED / DISCONNECTED).
LAST RESET AT:	THE DATE OF THE LAST RESETTING OF THE COUNTERS.
DP CYCLES	THE NUMBER OF FLUSH CYCLES STARTED DUE TO A DP SIGNAL.
FLUSHING INTERVAL CYCLES	THE NUMBER OF FLUSH CYCLES STARTED DUE TO THE TIME INTERVALS PROGRAM. ALSO COUNT THE ANTIFREEZE PROTECTION INTERVALS FLUSHES
PRESET	THE NUMBER OF FLUSH CYCLES STARTED DUE TO THE PRESET DAILY START TIME AND THE CURRENT STATUS OF THIS PROGRAM.
MANUAL CYCLES	THE NUMBER OF FLUSH CYCLES STARTED DUE TO A MANUAL START COMMAND ISSUED BY THE USER.
TOTAL FLUSHING CYCLES	THE TOTAL NUMBER OF FLUSH CYCLES STARTED FOR ANY REASON.
RESET BUTTON	CLICK THIS BUTTON TO RESET THE COUNTERS TO ZERO.

4.5.1.3.3 The Alerts Tab

ELEMENT	DESCRIPTION
THE UPPER RED / GREY LINE	DISPLAYS THE NAME OF THE CURRENTLY CONNECTED CONTROLLER AND THE COMMUNICATION STATUS (CONNECTED / DISCONNECTED).
THE SECOND LINE	ENABLES SORTING ALERTS BETWEEN TWO DATES AND RESETTING AN ALERT.
THE ALERTS LIST	DISPLAYS THE ALERT MESSAGES ACCORDING TO THEIR OCCURRENCE TIME AND DATE. SEE APPENDIX B. ALARMS AND FAULTS LIST.

4.5.1.3.4 The Reports Tab

ELEMENT	DESCRIPTION
THE UPPER RED / GREY LINE	DISPLAYS THE NAME OF THE CURRENTLY CONNECTED CONTROLLER AND THE COMMUNICATION STATUS (CONNECTED / DISCONNECTED).
THE SECOND LINE	DISPLAYS ICONS OF THE DIFFERENT FLUSH TYPES. SELECT THE DESIRED ICONS TO BE DISPLAYED ON THE CHART.
THE CHART WINDOW	DISPLAYS THE NUMBER OF FLUSH CYCLES ACCORDING TO THE SELECTED ICONS.
TOTAL FLUSHING CYCLES	THE TOTAL NUMBER OF FLUSH CYCLES CURRENTLY DISPLAYED IN THE CHART WINDOW.
THE LOWER BLACK LINE	ENABLES THE USER TO SELECT THE CHART'S TIME SPAN (DAY, WEEK, MONTH).

4.5.1.3.5 The History Tab

ELEMENT	DESCRIPTION
THE UPPER RED / GREY LINE	DISPLAYS THE NAME OF THE CURRENTLY CONNECTED CONTROLLER AND THE COMMUNICATION STATUS (CONNECTED / DISCONNECTED).
THE SECOND LINE	ENABLES SORTING EVENTS BETWEEN TWO DATES AND DELETING AN EVENT.
THE BLACK LINE	ENABLES FILTERING EVENTS ACCORDING TO THE FOUR FLUSH TYPES (DP, INTERVAL, MANUAL, PRESET, ANTI FREEZE).
THE EVENTS LIST	DISPLAYS THE EVENTS MESSAGES ACCORDING TO THEIR OCCURRENCE TIME AND DATE. FLUSH CAUSE, FLUSH DATE, AND FLUSH TIME IS SHOWN IN EVERY RAW OF THE LIST. CLICK  ICON TO SEE THE FOLLOWING INFORMATION: <ul style="list-style-type: none"> • INLET PRESSURE BEFORE THE FLUSH • OUTLET PRESSURE BEFORE THE FLUSH • DP PRESSURE BEFORE THE FLUSH • DP PRESSURE AFTER (THE DP MEASURED AFTER FLUSHING. INTERVAL BETWEEN END OF FLUSHING AND DP MEASURING IS DETERMINED BY "IGNORE DP" PARAMETER).

4.5.1.3.6 Settings menu

Enter the Settings menu by clicking on the  icon in the upper right corner of any of the 5 tabs. This menu contains controller settings. See the list of settings with description in Appendix A. AlphaDisc™ CLD Controller Settings. Click the setting to change it. Click **Save** to save changes.

5 AlphaDisc™ CLD Controller Operation

The AlphaDisc™ CLD Controller can be operated in four ways:

1. Hardware interface (AlphaDisc™ CLD control panel buttons).
2. Via AlphaDisc™ CLD Desktop Application.
3. Via AlphaDisc™ CLD Mobile Application.
4. Via AlphaDisc™ BLE Mobile Application.

This chapter describes the AlphaDisc™ CLD controller operation methods. The following is the instructions for all the applicable controlling methods.

5.1 ALPHADISC™ CLD CONTROLLER BUTTONS

There are two main buttons on the AlphaDisc™ CLD controller control panel. Following is the functionality description of the buttons:

	LEFT BUTTON	RIGHT BUTTON
SHORT PUSH	TURN ON DISPLAY BACKLIGHT	START MANUAL FLUSH
LONG PUSH	ENTER PAIRING MODE	FORCE FULL CLOUD SYNCHRONIZATION

5.2 ALPHADISC™ CLD CONTROLLER SHARING

AlphaDisc™ CLD controller can communicate via cloud with one account only. If another account needs access to the controller via cloud communication, use the share site function. Shared site will be displayed as 'Linked site' in the sites list. Linked account has full access to controller operation but cannot change the site information and cannot share the site forward (to additional user).

To share the site using AlphaDisc™ CLD Desktop application:

1. Sign in to AlphaDisc™ CLD Desktop application.
2. Go to **Sites manager** screen in the left menu and choose with site to share.
3. Click the **Invite** icon on the site you want to share.

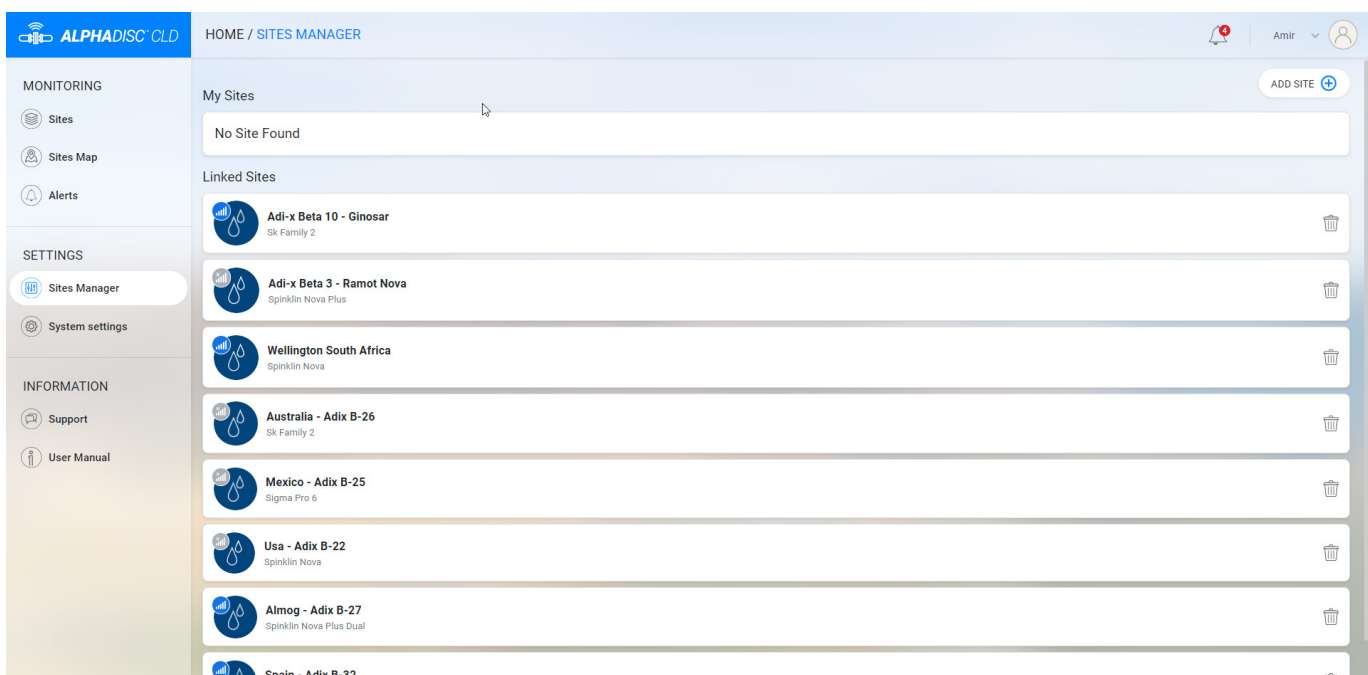

4. An Invite window will open. Enter email address of the user you want to share your site with. Click OK. The invitation has been sent.

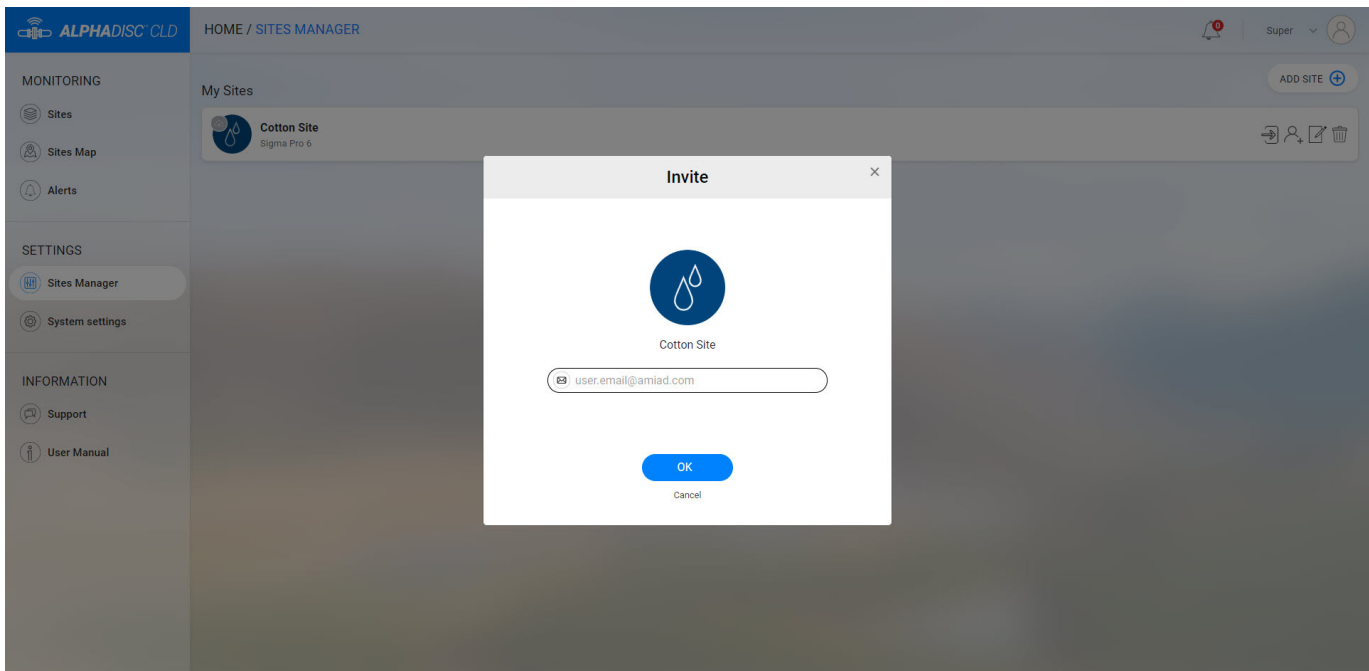

5. An invitation notification will appear in the Notifications Center. Click **ACCEPT** to accept the invitation. The site will appear in the linked sites list.

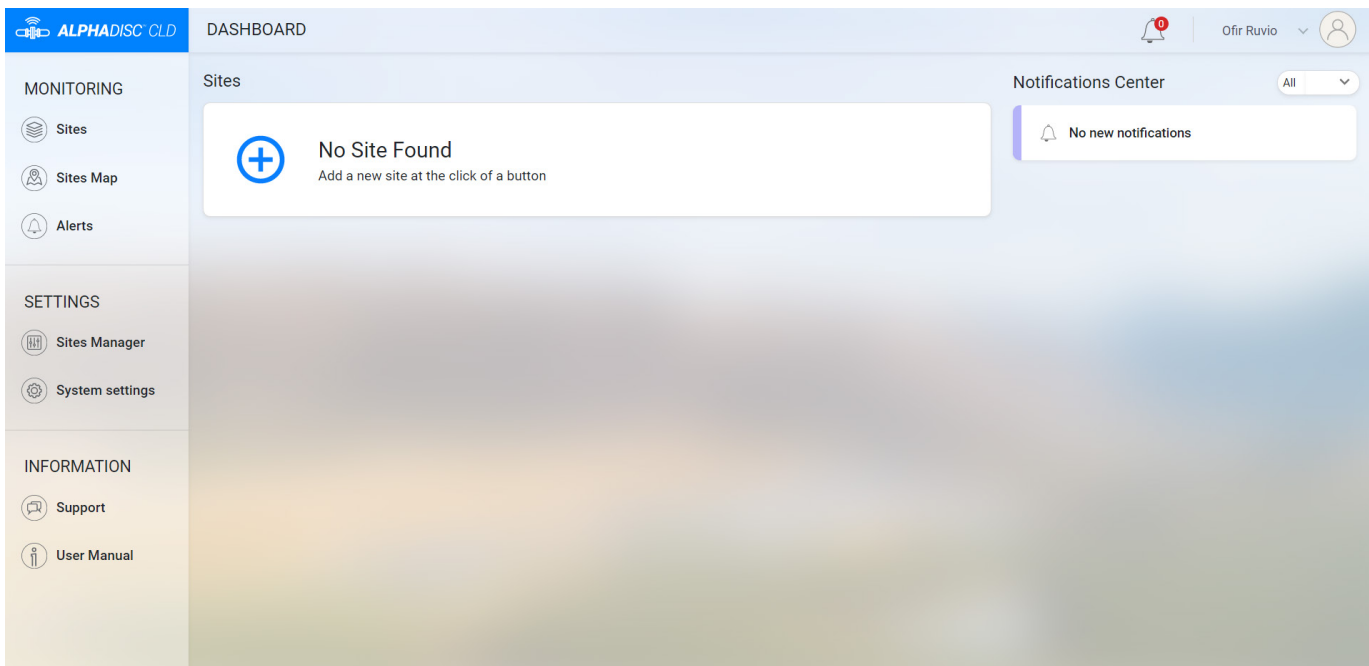

To share the site using AlphaDisc™ CLD Mobile application:

1. Sign in to AlphaDisc™ CLD Mobile application.
2. On **Sites manger** screen click the **Share** icon on the site you want to share.
3. Click the **Invite** icon in the upper right corner to send a new invitation.
4. In the **Invite** window enter the email address of the user you want to share your site with. Click **OK**. The invitation has been sent.

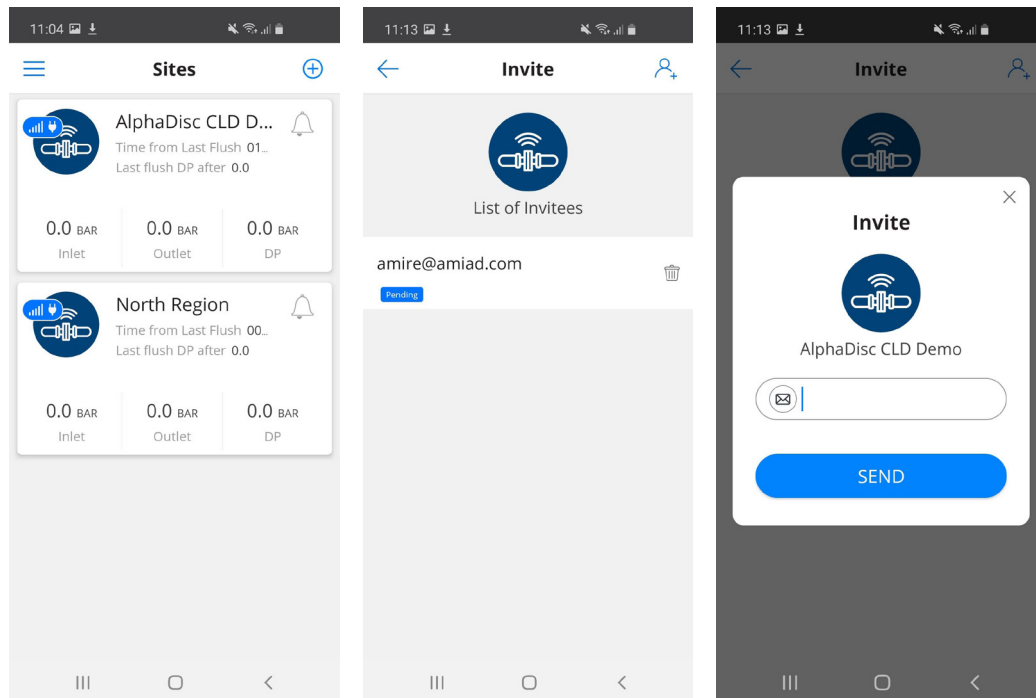

5. In the account you shared with an invitation notification will appear on the **Sites Manager** screen. Click **ACCEPT** to accept the invitation. The site will appear in the list of linked sites.

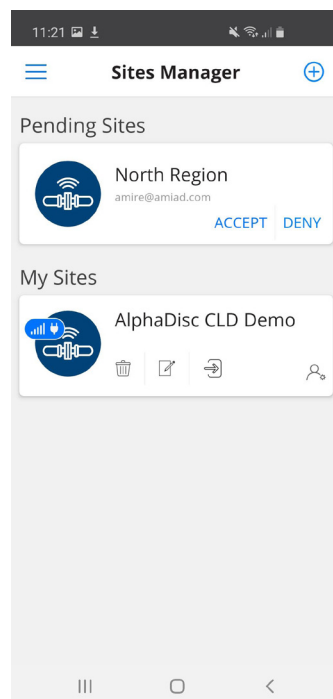

5.3 ALPHADISC™ CLD CONTROLLER PARAMETERS SETTING

AlphaDisc™ CLD Controller parameters can be set via AlphaDisc™ CLD Desktop application, AlphaDisc™ CLD Mobile application, and AlphaDisc™ BLE Mobile application. See the list of settings and their description in Appendix A. AlphaDisc™ CLD Controller Settings”.

Access to the Technician Settings requires a 4-digit code: **1234**.

The Technician Settings contain the system’s basic and fundamental settings.

NOTICE

Do not change any of these settings if you are not fully familiar with the specific filtration system, filter type, and controller. Incorrect settings may lead to nonoperational system.

To set the controller parameters using AlphaDisc™ CLD Desktop application:

1. Open AlphaDisc™ CLD Desktop application. Sign in with your email and password if needed.
2. Go to **Sites** tab in left menu and select the site where you want to set parameters.
3. Go to **Settings** tab. Here you can set parameters.

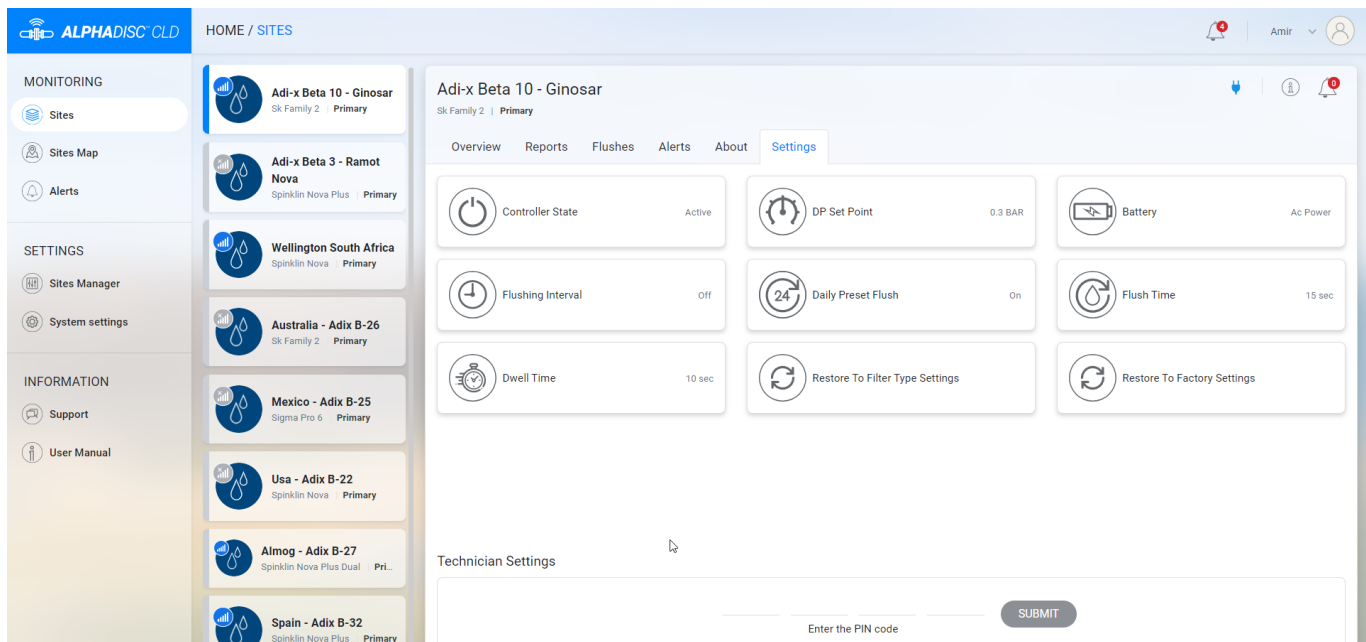

4. Enter 4-digit code (1234) and click **SUBMIT** to enter the Technician Settings.

NOTICE

Do not change any of these settings if you are not totally familiar with the specific filtration system, filters, and controller. Incorrect settings may cause the system to become nonoperational!

5. Make sure to click **Save** after changing any of the settings.

To set the controller parameters using AlphaDisc™ CLD Mobile application:

1. Sign in to AlphaDisc™ CLD Mobile application.
2. Enter the **Sites** screen and select the site to set parameters.
3. Click  to open **Settings** menu.

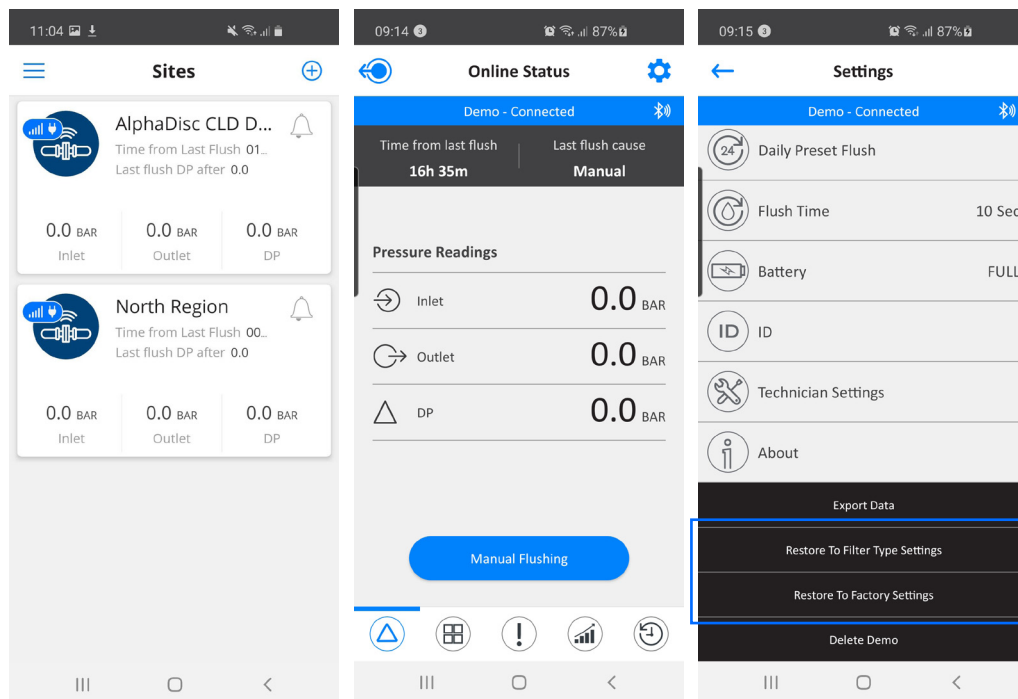

4. Click **Technician Settings** and enter 4-digit code (1234) to access Technician Settings.

NOTICE

Do not change any of these settings if you are not fully familiar with the specific filtration system, filter type, and controller. Incorrect settings may lead to nonoperational system.

5. Make sure to click **Save** after changing any of the settings.

To set the controller parameters using AlphaDisc™ BLE Mobile application:

1. Open AlphaDisc™ BLE Mobile Application. Verify that the controller is within Bluetooth® range (Bluetooth® icon is blue).
2. Select the required site where you want to set the parameters.
3. Click  to open **Settings** menu.

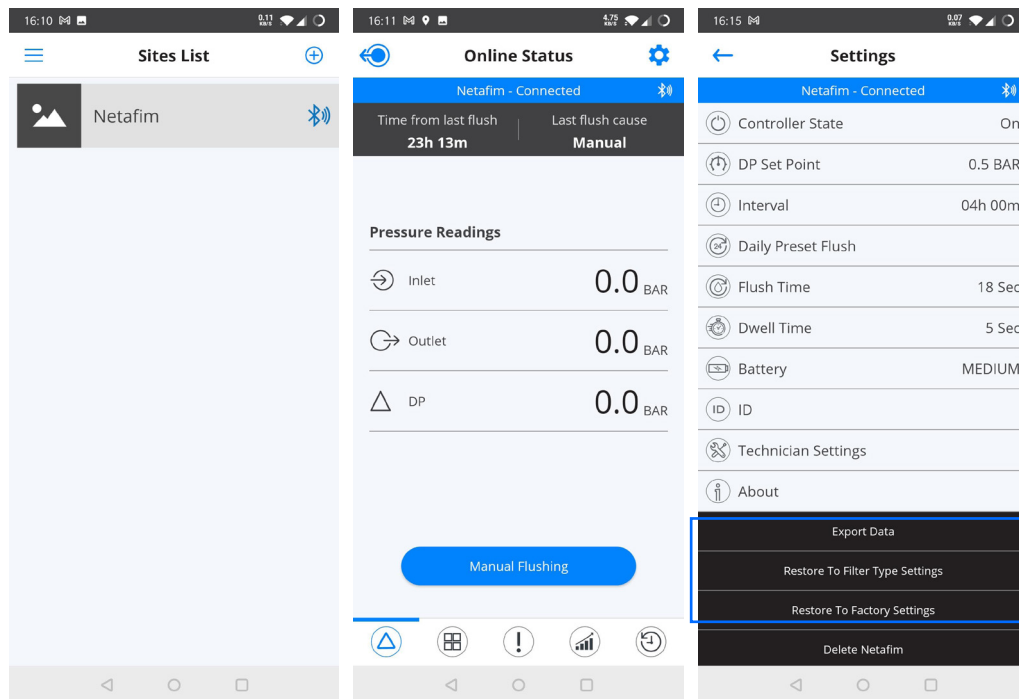

4. Click **Technician Settings** and enter 4-digit code (1234) to access Technician Settings.

 **NOTICE**

Do not change any of these settings if you are not totally familiar with the specific filtration system, filters, and controller. Incorrect settings may cause the system to become nonoperational!

5. Make sure to click **Save** after changing any of the settings.

5.4 ALPHADISC™ CLD CONTROLLER PARAMETERS RESTORATION

AlphaDisc™ CLD Controller has two options for parameters restoration:

1. **Restore to Filter Type Settings** – reset the controller’s data and restore the default parameters for the current filter type which is controlled by this controller.
2. **Restore to Factory Settings** – delete all the controller’s data and restore the factory default settings. The default filter model will be according to the filter provided with the controller, or according to the customer’s initial settings.

You can perform parameters restoration via AlphaDisc™ CLD Desktop application, AlphaDisc™ CLD Mobile application, and AlphaDisc™ BLE Mobile application.

To restore parameters using AlphaDisc™ CLD Desktop application:

1. Sign in to AlphaDisc™ CLD Desktop application.
2. Go to **Sites** tab in the left menu and select the required site.
3. Go to **Settings** tab and click **Restore to Filter Type Settings** or **Restore to Factory Settings** (see options above).

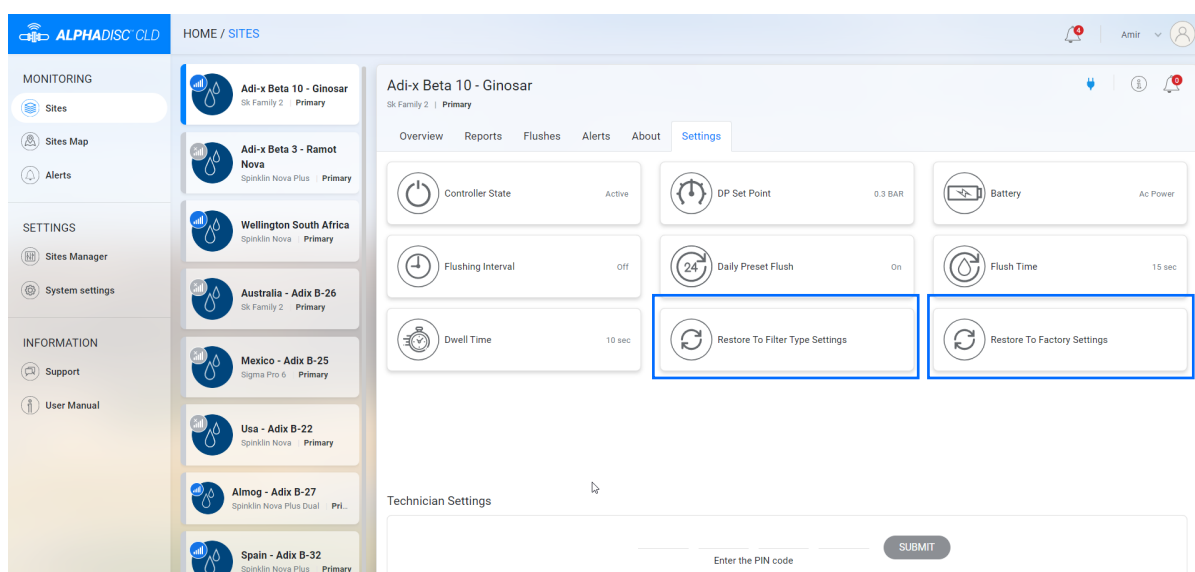

4. Click **OK** in the dialog window to approve the settings restoration.

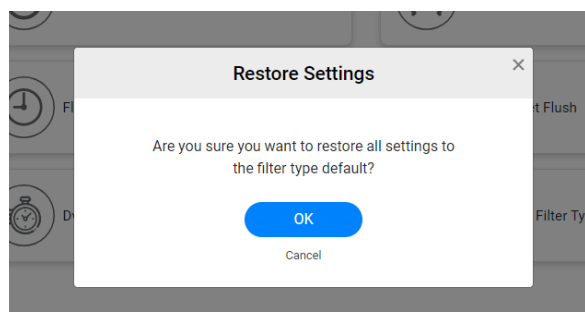
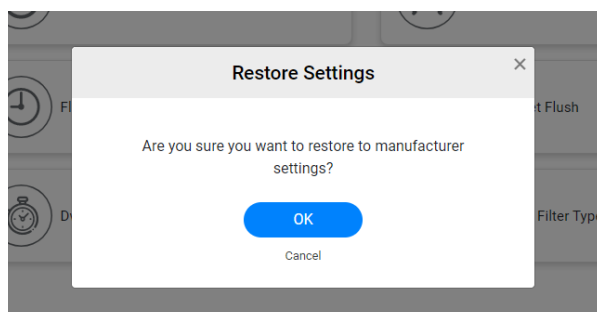

To restore parameters using AlphaDisc™ CLD Mobile application:

1. Signin to AlphaDisc™ CLD Mobile Application.
2. On **Sites** screen select the required site.
3. Click  to open **Settings** menu.
4. Click **Restore to Filter Type Settings** or **Restore to Factory Settings** (see options above).

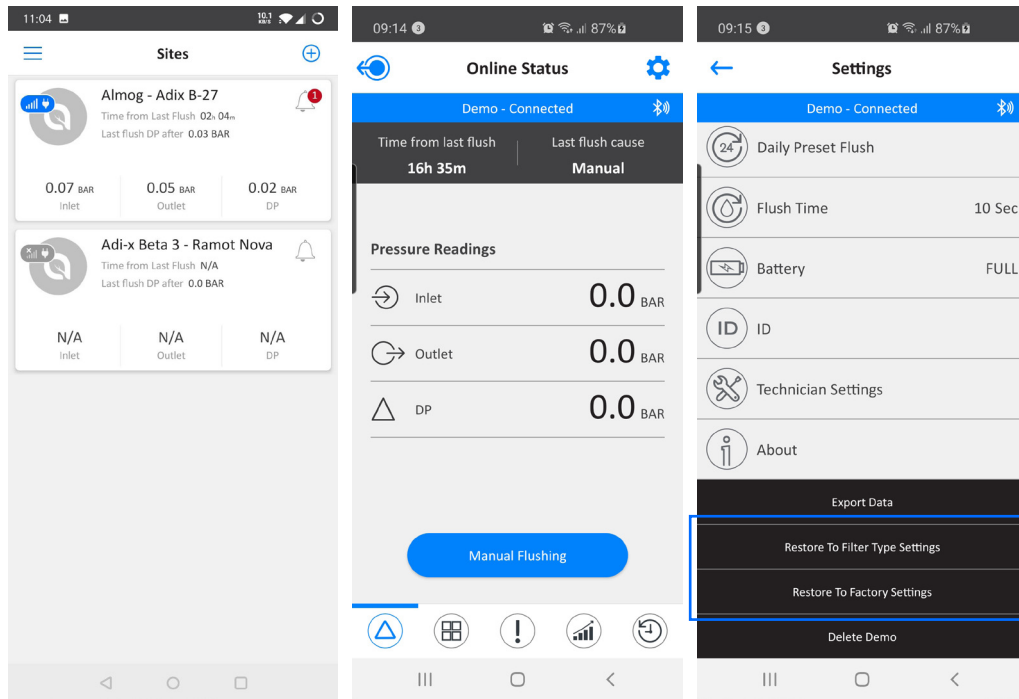

5. Click **OK** in the dialog window to approve the settings restoration.

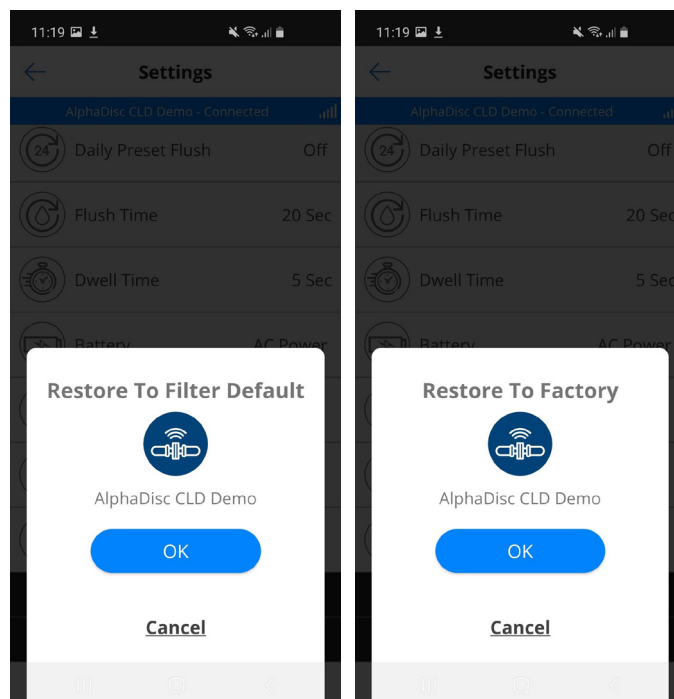

To restore parameters using AlphaDisc™ BLE Mobile application:

1. Open AlphaDisc™ BLE Mobile Application. Verify that the controller is within Bluetooth® range (Bluetooth® icon is blue).
2. Select the required site where you want to restore the parameters.
3. Click  to open **Settings** menu.
4. Click **Restore to Filter Type Settings** or **Restore to Factory Settings** (see options above).

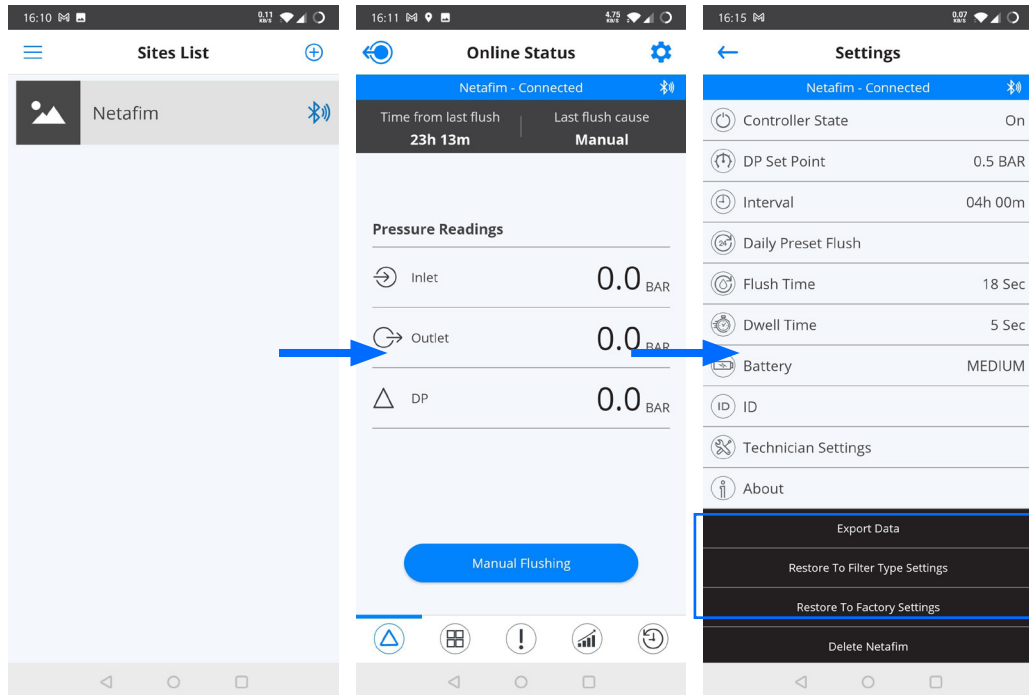

5. Click **OK** in the dialog window to approve the settings restoration.

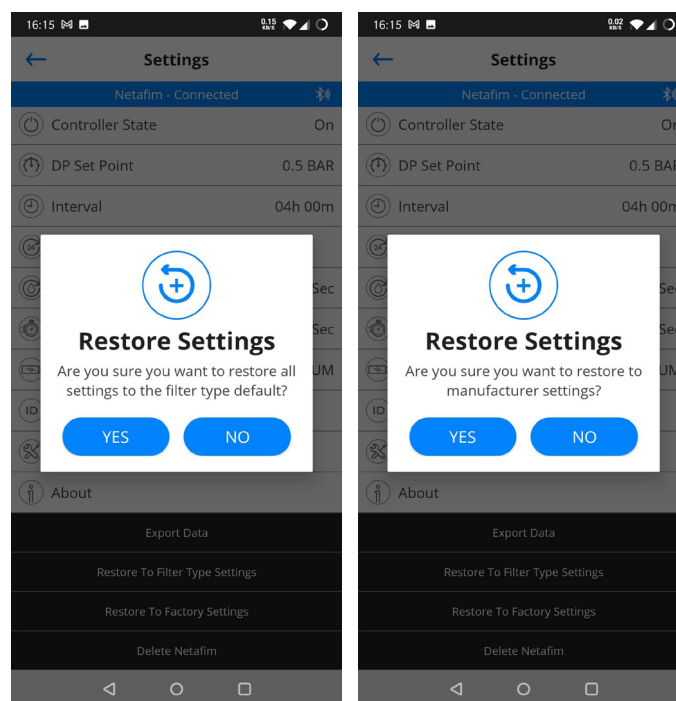

5.5 ALPHADISC™ CLD CONTROLLER COUNTERS RESET

AlphaDisc™ CLD Controller has five flushing cycles counters:

1. **Total flushing cycles** – overall number of cycles performed by the controller during operation. This number cannot be reset.
2. **DP cycles** – number of flushing cycles started due to a DP signal.
3. **Flushing Interval cycles** – number of flush cycles started due to the time intervals program.
4. **Manual cycles** – number of flush cycles initiated manually by the user.
5. **Preset cycles** – number of flush cycles started due to the preset start times.

Counters 2-5 can be reset via AlphaDisc™ CLD Desktop application, AlphaDisc™ CLD Mobile application, and AlphaDisc™ BLE Mobile application.

To reset the counters using AlphaDisc™ CLD Desktop application:

1. Sign in to AlphaDisc™ CLD Desktop application.
2. Go to **Sites** tab in left menu and select the required site.
3. Go to **Overview** tab and click **Reset** in the Flushing Cycles field. The counters will reset.

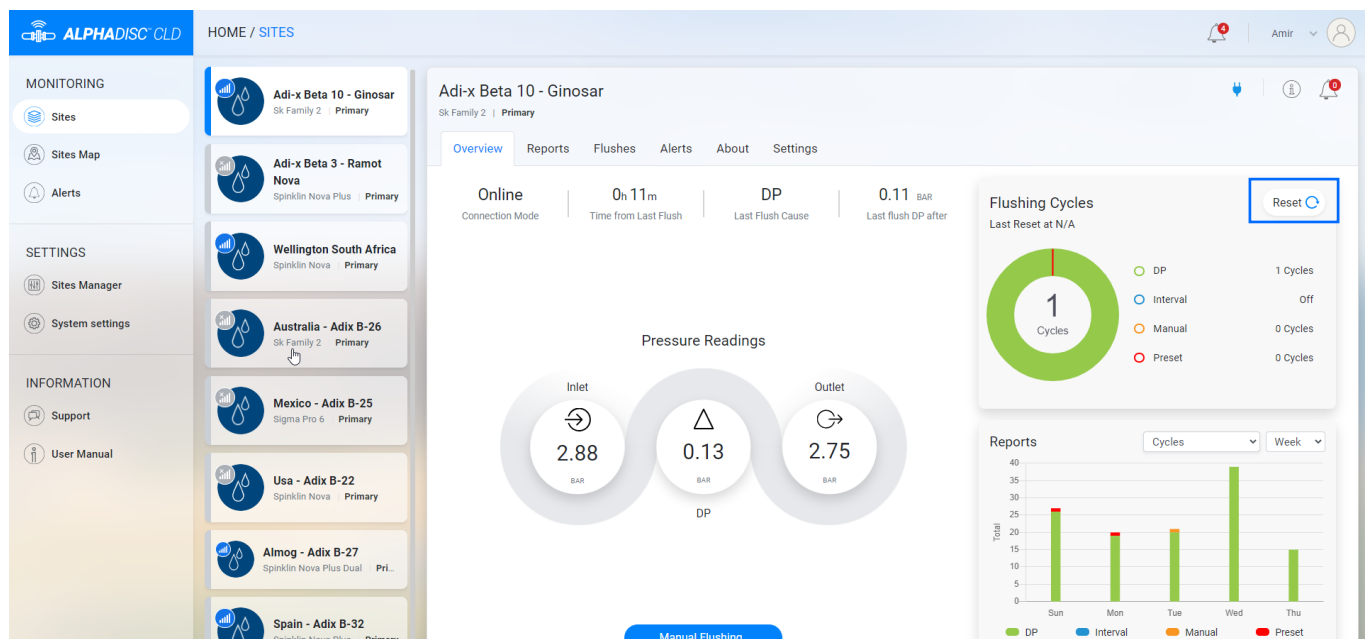

To reset the counters using AlphaDisc™ CLD Mobile application:

1. Sign in to AlphaDisc™ CLD Mobile Application.
2. On **Sites** screen select the site where you want to reset counters.
3. Go to **Counters** tab.
4. Click **Reset** in the middle of the screen. The counters will reset.

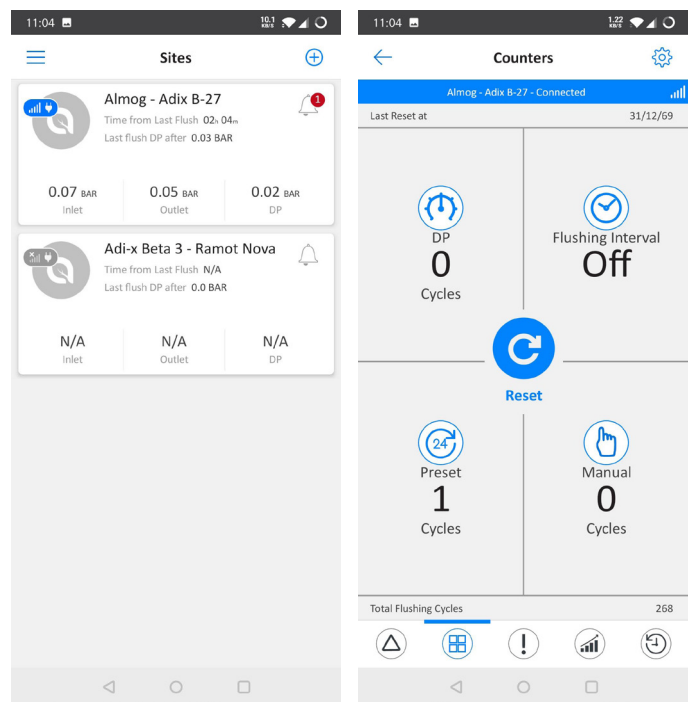

To reset the counters using AlphaDisc™ BLE Mobile application:

1. Open AlphaDisc™ BLE Mobile Application. Verify that the controller is within Bluetooth® range (Bluetooth® icon is blue).
2. Click the required site.
3. Go to **Counters** tab.
4. Click **Reset** in the middle of the screen. The counters will reset.

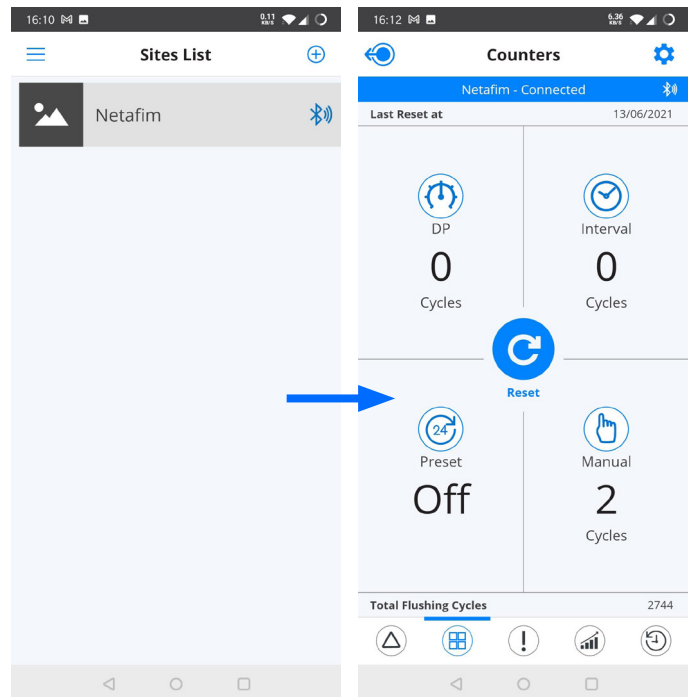

5.6 MANUAL FLUSHING

Manual flushing can be performed manually via AlphaDisc™ CLD controller panel, or remotely via AlphaDisc™ CLD Desktop application, AlphaDisc™ CLD Mobile application, and AlphaDisc™ BLE Mobile application.

To initiate manual flushing using the AlphaDisc™ CLD controller panel:

1. Open the AlphaDisc™ CLD protection cover.
2. If needed, press the left button to enable LED backlight.
3. Press the right button (short press). The flushing will start.



To initiate manual flushing using AlphaDisc™ CLD Desktop application:

1. Sign in to AlphaDisc™ CLD Desktop application.
2. Go to **Sites** tab in left menu and select the required site where you want to initiate manual flushing.
3. On **Overview** tab click **Manual Flushing**. The flushing will start.

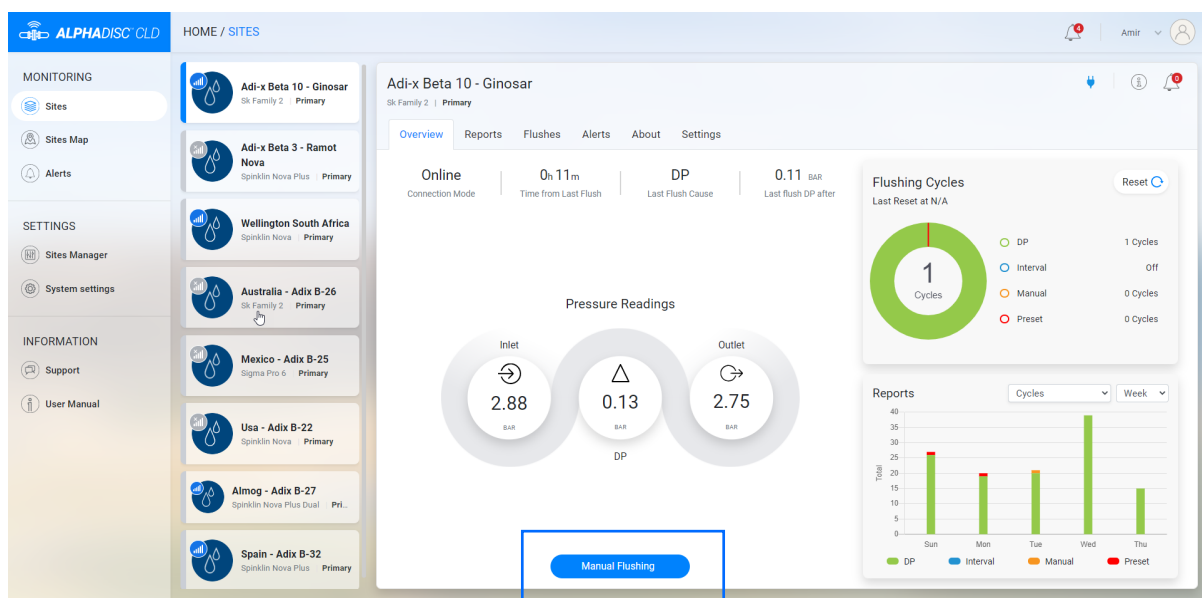

To initiate manual flushing using AlphaDisc™ CLD Mobile application:

1. Sign in to AlphaDisc™ CLD Mobile Application.
2. On **Sites** screen select the required site.
3. On **Online Status** tab select **Manual Flushing**. The flushing will start.

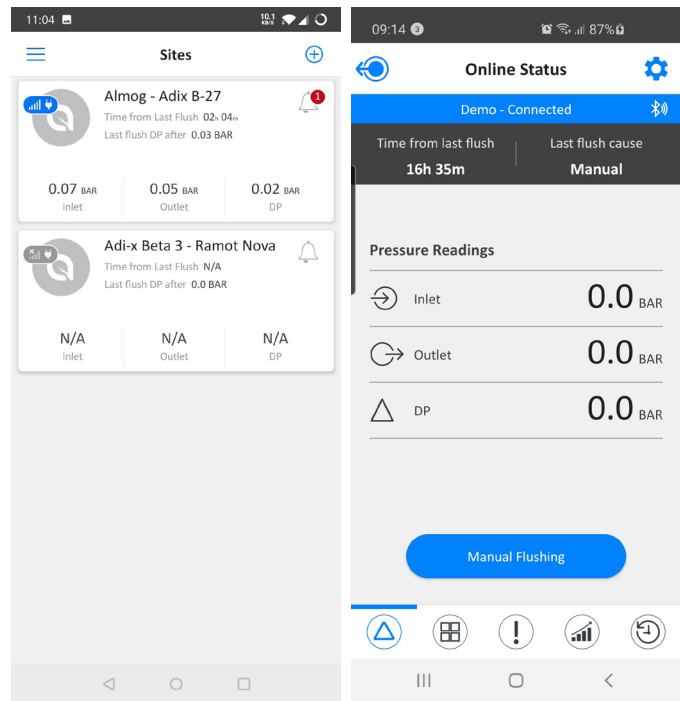

To initiate manual flushing using AlphaDisc™ BLE Mobile application:

1. Open AlphaDisc™ BLE Mobile Application. Verify the controller is within Bluetooth® range (Bluetooth® icon is blue).
2. Click the required site where you want to initiate manual flushing.
3. On **Online Status** tab select **Manual Flushing**. The flushing will start.

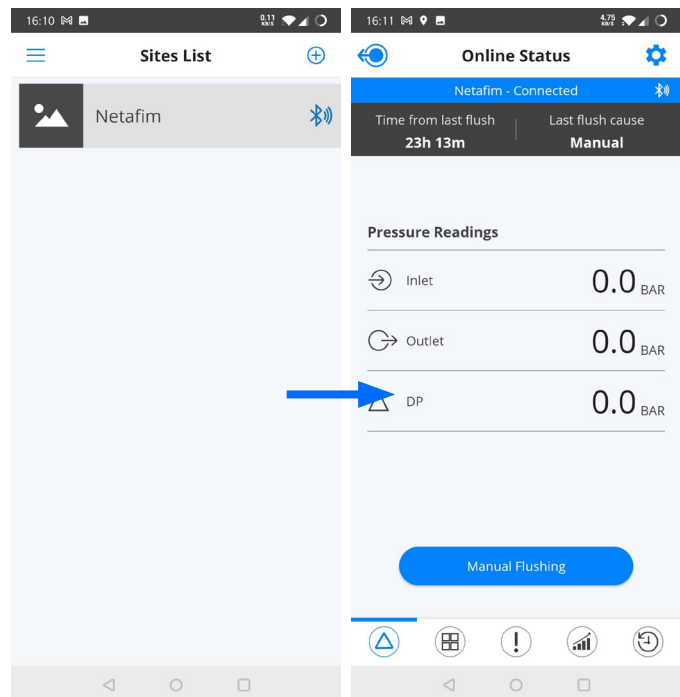

5.7 DOWNLOADING REPORTS

Interfacing the AlphaDisc™ CLD controller via the AlphaDisc™ BLE Mobile application, allows logging, storing, downloading, and exporting status and operation data through the user's mobile device.

1. Sign in to AlphaDisc™ BLE Mobile Application. Verify the controller is within Bluetooth® range (Bluetooth® icon is blue).
2. Select the site you want to download report for.
3. Click  to open **Settings** menu. Click **Export Data**.

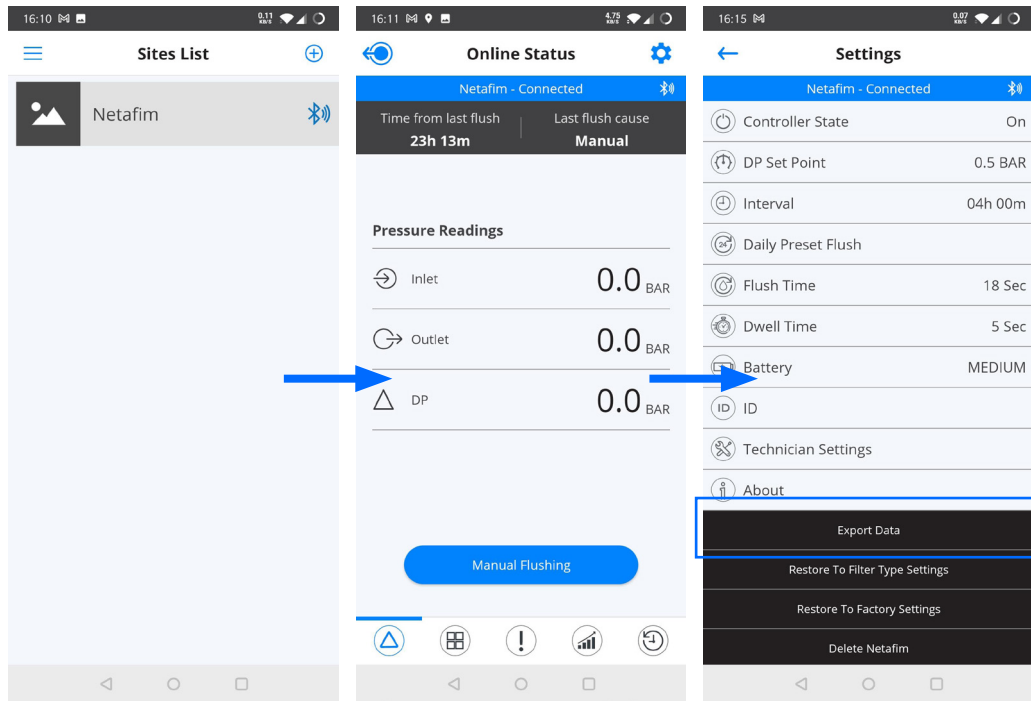

4. AlphaDisc™ BLE application displays the various options for sending the reports, depending on the general communication applications installed on your mobile device. Select the preferred application, the recipient, and send the reports.
5. AlphaDisc™ BLE application sends 5 reports in CVS (Excel file format):
system-id, parameters-setup, flush-events, alarm-events, and params-setup-audit.

5.8 CHAINING ALPHADISC™ CLD CONTROLLERS

AlphaDisc™ CLD controller can be set as primary controller that controls up to 3 secondary AlphaDisc™ CLD controllers. Primary controller flushing trigger is performed by the secondary controllers. All flush settings are set on each secondary controller separately

To chain controllers:

1. Connect each secondary controller to the primary controller using Ext A and B contacts.

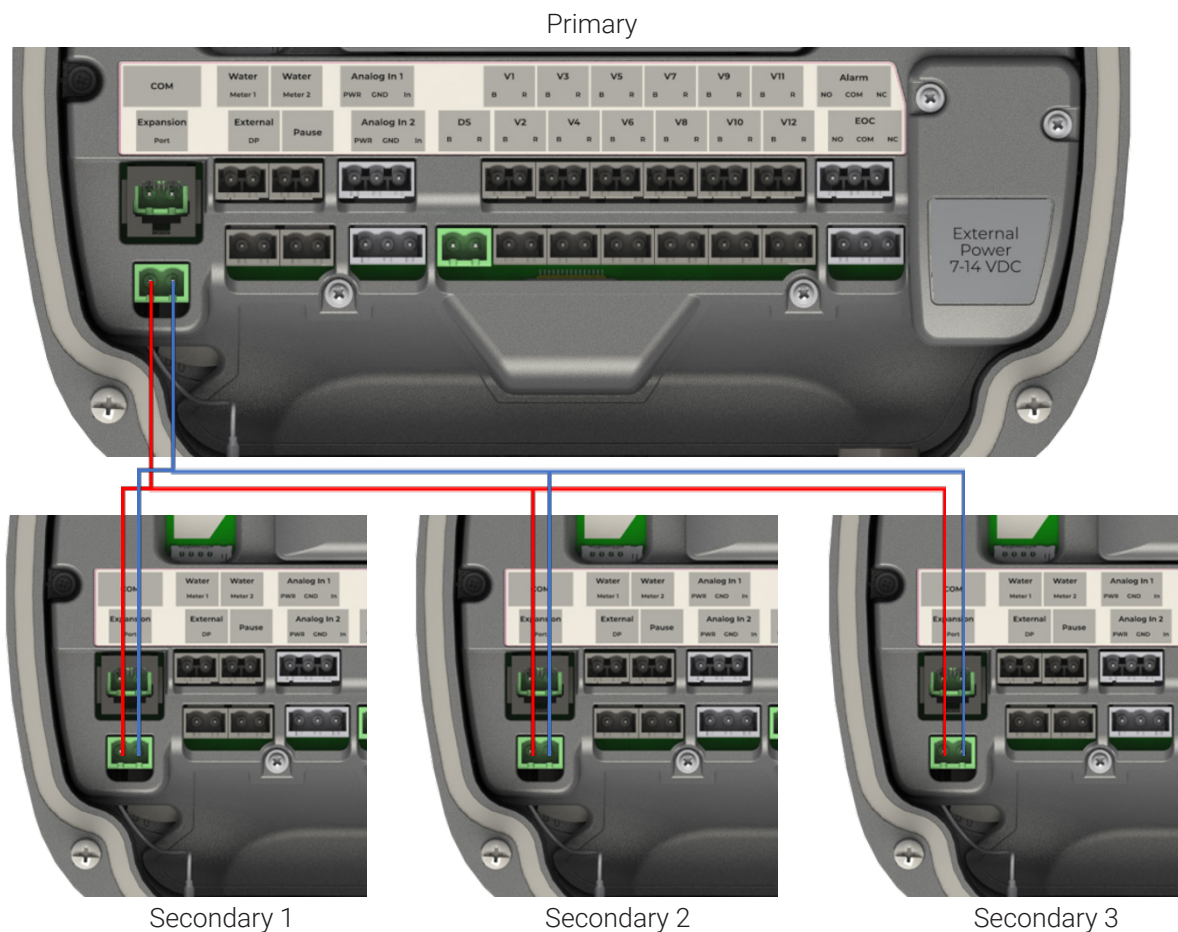

2. Set the primary controller Operation mode to **Primary** and select the number of the secondary controllers (for primary controller settings - see 5.3).
3. Set the secondary controllers Operation mode to **Secondary** (see 5.3).

6 Appendix A.

AlphaDisc™ CLD Controller Settings

This Appendix contains the list of all AlphaDisc™ CLD Controller settings with descriptions. The settings are available on Settings tab of the site in AlphaDisc™ CLD applications (see 4.3 and 4.4).

6.1 THE BASIC SETTINGS

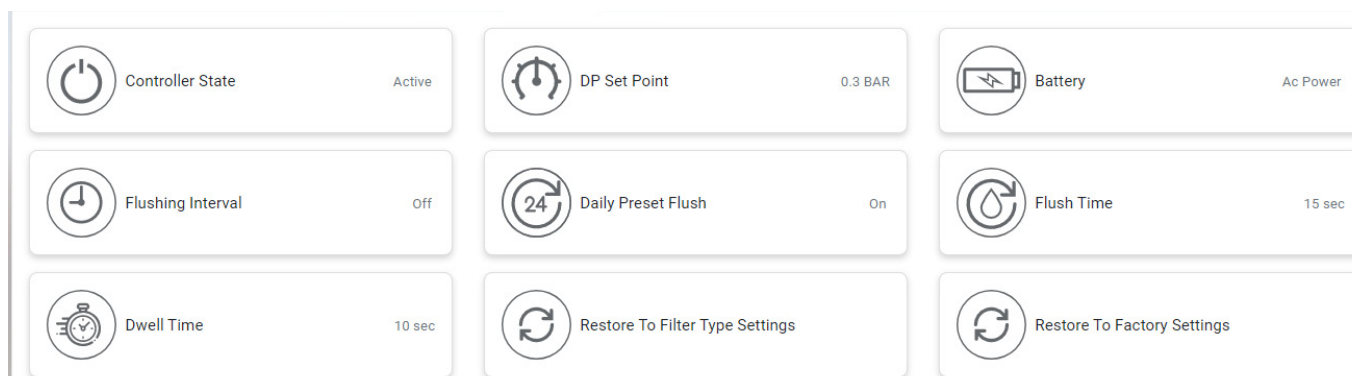





























SETTING	DESCRIPTION
CONTROLLER STATE	DISPLAYS THE CURRENT CONTROLLER STATE AND ALLOWS THE USER TO SWITCH THE CONTROLLER ON PAUSE OR ACTIVE
DP SET POINT	DISPLAYS THE DP LEVEL FOR STARTING A FLUSH CYCLE AND ALLOWS THE USER TO ENABLE OR DISABLE THE DP OPERATION. THE RECOMMENDED SETTING IS DISPLAYED AT THE BOTTOM OF THE SCREEN.
FLUSHING INTERVAL	ALLOWS THE USER TO SET THE TIME INTERVALS FOR FLUSHING AND ENABLE OR DISABLE THE FLUSHING ACCORDING TO TIME INTERVALS.
DAILY PRESET FLUSH	ALLOWS THE USER TO SET SPECIFIC FLUSHING START TIMES. START TIME CAN BE SET AS DAILY START TIMES OR SINGLE TIME START TIMES. THE USER CAN SET UP TO 8 START TIMES.
FLUSH TIME	ALLOWS THE USER TO SET THE DURATION OF THE FLUSH OPERATION.
DWELL TIME	IF THE SYSTEM OPERATES TWO OR MORE FILTERS, THIS PARAMETER ALLOWS THE OPERATOR TO SET THE TIME DELAY BETWEEN THE FLUSH CYCLES OF THE FILTERS.
BATTERY	DISPLAYS THE CURRENT CHARGE LEVEL OF THE CONTROLLER'S BATTERIES.
ID (ONLY IN ALPHADISC™ CLD MOBILE APPLICATION)	ALLOWS THE USER TO SET THE SITE'S PICTURE, NAME, AND ID PARAMETERS SUCH AS: FILTER MODEL, CONTROLLER SERIAL NUMBER AND FILTER SERIAL NUMBER. THE SECOND SCREEN ALLOWS THE USER TO SELECT THE TYPE OF THE WATER SOURCE, FLOW RATE, THE WORKING PRESSURE, AND THE FILTRATION DEGREE OF THE FILTER. THE THIRD SCREEN ALLOWS THE USER TO SELECT SITE LOCATION. CLICK "SUBMIT" TO SUBMIT THE DATA.
RESTORE TO FILTER TYPE SETTINGS	ALLOWS THE USER TO RESET THE CONTROLLER'S DATA AND RESTORE THE DEFAULT PARAMETERS FOR THE CURRENT FILTER TYPE WHICH IS CONTROLLED BY THIS CONTROLLER.
RESTORE TO FACTORY SETTINGS	ALLOWS THE USER TO DELETE ALL THE CONTROLLER'S DATA AND RESTORE THE FACTORY DEFAULT SETTINGS; THE DEFAULT FILTER MODEL WILL BE ACCORDING TO THE FILTER PROVIDED WITH THE CONTROLLER, OR ACCORDING TO THE CUSTOMER'S INITIAL SETTINGS.

6.2 TECHNICIAN SETTINGS

This section contains the system's basic and fundamental settings.

NOTICE

Do not change any of these settings if you are not fully familiar with the specific filtration system, filter type, and controller. Incorrect settings may lead to nonoperational system.

 Communication Method Online	 Filter Type Spinklin Nova	 Number of Filtration Units 2
 Operation Mode Primary	 Interval Flush Pause Off	 Ignore DP After Flush 01m 00s
 DP Delay 00m 10s	 DP Sampling Interval	 High DP Alarm 0.7 BAR
 Repeated Flashes to Start Fault Mode 9	 Cycle Time for Continuous 1 min	 Action to Take in Continuous Fault Mode Ignore
 Downstream Valve Off	 System DP Device Primary	 Downstream Valve Address Primary
 External DP address Primary	 Flush Sequence Standard	 Solenoid Pulse Length 80 ms
 End Of Cycle Relay Output Off	 Alarm Relay Off	 Water Meter 00h 30m
 Water Meter 1 Off	 Water Meter 2 Off	 Analog Input
 Analog Input 1 Off	 Analog Input 2 Off	 Freezing Protection On
 LCD Display Unit BAR		

Access to the Technician Settings requires a 4-digit code: "1234".

SETTING	DESCRIPTION
COMMUNICATION METHOD	ONLINE OR OFFLINE. WHEN ONLINE, THE CONTROLLER IS CONNECTED TO THE CLOUD AND CONSTANTLY PERFORMS SYNCHRONIZATION, ALLOWING REAL-TIME COMMUNICATION WITH THE CONTROLLER. WHEN OFFLINE, THE CONTROLLER CONNECTS TO THE CLOUD ONCE A DAY AT A DEFINED HOUR. DURING THIS CONNECTION, THE CONTROLLER WILL UPLOAD THE CONTROLLER HISTORY LOG AND DOWNLOAD PENDING CONFIGURATION. IN OFFLINE MODE THE CONTROLLER WILL INITIATE COMMUNICATION IN CASE OF ALERT. ANY CHANGES IN CONFIGURATION WHILE THE CONTROLLER IS OFFLINE WILL BE STORED ON THE CLOUD UNDER PENDING STATUS AND WILL BE DOWNLOADED TO THE CONTROLLER WHEN CONNECTED.
FILTER TYPE	SELECT THE SPECIFIC FILTER(S) MODEL CONTROLLED BY THE CURRENT CONTROLLER.
NUMBER OF FILTRATION UNITS	SELECT THE NUMBER OF FILTRATION UNITS CONNECTED TO THE CONTROLLER (1-12).
OPERATION MODE	SELECT THE OPERATION MODE OF THIS CONTROLLER: PRIMARY = THE FIRST CONTROLLER IN A CHAIN OF CONTROLLERS OR A STAND-ALONE CONTROLLER. SECONDARY = A MEMBER OF A CHAIN OF CONTROLLERS WHICH IS CONTROLLED BY A PRIMARY CONTROLLER.
INTERVAL FLUSH PAUSE	WHEN ENABLED, IF INTERVAL FLUSH PERIOD FINISHED AND THE CURRENT DP IS BELOW TIME OPERATION MODE THRESHOLD, THE CONTROLLER WILL NOT PERFORM FLUSHING.
IGNORE DP	SET THE TIME DURATION AFTER THE END OF A FLUSH CYCLE DURING WHICH THE DP READING IS IGNORED.
DP DELAY	SET THE TIME THAT THE DP SIGNAL SHOULD BE ON BEFORE STARTING FLUSHING ACCORDING TO A DP SIGNAL. THIS PARAMETER IS USED TO ELIMINATE UNNECESSARY FLUSHING DUE TO A MOMENTARY HIGH DP.
HIGH DP ALARM	SET THE DP LEVEL FOR ISSUING A HIGH DP ALARM MESSAGE (SYSTEM LOG).
REPEATED FLUSHES TO START FAULT MODE	SET THE NUMBER OF CONTINUOUS FLUSH CYCLES SO THE ALPHADISC™ BLE CONTROLLER ENTERS FAULT MODE.
CYCLE TIME FOR CONTINUOUS	SET THE CYCLE TIME FOR COUNTING A FLUSH CYCLE AS CONTINUOUS FLUSHING. IF THE TIME BETWEEN TWO FLUSH CYCLES IS SHORTER THAN "CYCLE TIME FOR CONTINUOUS" – THEN IT IS COUNTED AS CONTINUOUS FLUSHING.
ACTION TO TAKE IN CONTINUOUS FAULT MODE	SELECT THE ACTION TO TAKE WHEN CONTINUOUS FAULT MODE IS DETECTED: IGNORE: IGNORE THE ALERT AND CONTINUE FLUSHING ACCORDING TO DP SET POINT. TIME ONLY: STOP FLUSHING ACCORDING TO DP MEASUREMENT AND FLUSH ACCORDING TO TIME INTERVAL ONLY.
DOWNSTREAM VALVE DELAY	DELAY BETWEEN DOWNSTREAM VALVE CLOSING AND START OF FILTER FLUSHING.
SYSTEM DP DEVICE	WHEN THERE IS A SYSTEM WITH PRIMARY AND SECONDARY CONTROLLERS, THE USER CAN DEFINE WHERE THE DP MEASUREMENT WILL BE PERFORMED: PRIMARY / SECONDARY 1 / SECONDARY 2 / SECONDARY 3.
DOWNSTREAM VALVE ADDRESS	WHEN THERE IS A SYSTEM WITH PRIMARY AND SECONDARY CONTROLLERS, THE USER CAN DEFINE WHERE THE PHYSICAL CONNECTION OF DOWNSTREAM VALVE IS LOCATED: PRIMARY / SECONDARY 1 / SECONDARY 2 / SECONDARY 3.
EXTERNAL DP ADDRESS	WHEN THERE IS A SYSTEM WITH PRIMARY AND SECONDARY CONTROLLERS, THE USER CAN DEFINE WHERE THE PHYSICAL CONNECTION OF EXTERNAL DP IS LOCATED: PRIMARY / SECONDARY 1 / SECONDARY 2 / SECONDARY 3.
FLUSH SEQUENCE	SET THE FLUSHING SEQUENCE AS FOLLOWS: STANDARD: FLUSH ORDER IS FROM FIRST TO LAST. REVERSE ORDER: FLUSH ORDER IS FROM LAST TO FIRST. ROTATE: <ul style="list-style-type: none"> • THE FIRST FLUSH STARTS FROM 1 AND FINISHES AT THE LAST • THE SECOND STARTS AT 2 AND FINISHES AT 1 • NEXT STARTS AT 3 AND FINISHES AT 2 • NEXT STARTS AT 4 AND FINISHES AT 3 • AND SO ON.

ELEMENT	DESCRIPTION
SOLENOID PULSE LENGTH	SET THE PULSE LENGTH FOR SOLENOID IN MS. DEFAULT VALUE: 80 MS.
END OF CYCLE RELAY OUTPUT	SET THE RELAY OPERATION ON END OF CYCLE EVENT (OFF / ON). DEFAULT VALUE: OFF. SET THE RELAY OPERATION TIME. DEFAULT VALUE: 10 SEC.
ALARM RELAY	SET THE RELAY OPERATION ON ALARM EVENT (OFF / ON). DEFAULT VALUE: OFF.
WATER METER	WATER METER INPUTS ALLOW CONNECTING EXTERNAL WATER METERS TO ALPHADISC™ CLD, RECORDING THE VALUES, AND COMPARING WITH FILTER SYSTEM VALUES / EVENTS. WATER METER INTERVAL (MIN) – SAMPLING INTERVAL FOR FLOW RECORD. DEFAULT VALUE: 30 MIN.
WATER METER 1	WATER METER SETTING PROPERTIES:
WATER METER 2	WATER METER PULSE VOLUME (LITER). DEFAULT VALUE: 100 LITERS. WATER METER ROLE (MAIN LINE / FLUSH) – SET THE WATER METER AS IT IS ASSEMBLED ON THE MAIN LINE OR ON THE FLUSH LINE. UNIT (LITER / GALLON). DEFAULT VALUE: LITER
ANALOG INPUT	ANALOG INPUT ALLOWS CONNECTING EXTERNAL ANALOG SENSOR TO ALPHADISC™ CLD, RECORDING THE VALUES, AND COMPARING WITH YOUR FILTER SYSTEM VALUES / EVENTS (AS PRESSURE, TEMPERATURE, CONDUCTIVITY, TURBIDITY, HUMIDITY). SAMPLING INTERVAL FOR RECORD: STABILIZATION TIME – THE TIME TO WAIT FROM SENSOR POWER UP UNTIL MEASUREMENT START. DEFAULT VALUE: 1 SEC. ANALOG INPUT INTERVAL – SAMPLING INTERVAL FOR ANALOG INPUT VALUE RECORD. DEFAULT VALUE: 1 HOUR.
ANALOG INPUT 1	ANALOG INPUT SETTING PROPERTIES:
ANALOG INPUT 2	INPUT TYPE (VOLT / MA) – SELECT THE INPUT TYPE. DEFAULT VALUE: MA LOWER VALUE (4 MA / 0 VOLT) – SET THE LOWER VALUE. HIGHER VALUE (20 MA / 10 VOLT) – SET THE HIGHER VALUE. SENSOR TYPE (PRESSURE, TEMPERATURE, CONDUCTIVITY, TURBIDITY, HUMIDITY). UNITS (BAR/PSI, CELSIUS/FAHRENHEIT, S/M, NTU, %). DEFAULT VALUE: BAR.
FREEZING PROTECTION	FREEZING PROTECTION – THIS FUNCTION IS TO PREVENT THE FILTER FROM FREEZING IN LOW TEMPERATURE WHILE IT IS CONNECTED TO WATER SOURCE. DEFAULT VALUE: ENABLE LOW TEMPERATURE THRESHOLD – TEMPERATURE SETPOINT TO START FILTER FLUSHING. DEFAULT VALUE: 4°C. PROTECTING FLUSHING INTERVAL – FLUSHING INTERVAL WHILE FREEZING PROTECTION IS ACTIVATED. DEFAULT VALUE: 60 MIN.
LCD DISPLAY UNIT	ALLOWS SWITCHING UNITS ON THE CONTROLLER SCREEN BETWEEN BAR AND PSI.

NOTICE

Make sure to press **SAVE** after changing any of the above settings.

7 Appendix B.

Alarms and Faults List

ALERT	POSSIBLE CAUSE	RECOMMENDED ACTION
LOW BATTERY	LOW BATTERY VOLTAGE	REPLACE ALL 4 CONTROLLER BATTERIES
LOW BATTERY PAUSE	CONTROLLER PAUSED DUE TO LOW BATTERY VOLTAGE	REPLACE ALL 4 CONTROLLER BATTERIES
HIGH DP ALARM	DP VALUE IS \geq HDA THRESHOLD (UNITS: BAR/100)	ALERT ONLY
HIGH DP FAULT	DP VALUE IS \geq HDF THRESHOLD (UNITS: BAR/100)	ALERT ONLY
CONTINUOUS MODE ALERT	CONTROLLER EXCEEDED NUMBER OF CONSECUTIVE FLUSHES FOR ALERTS	CHECK CONFIGURATION/CHECK DP: IF HIGH, PERFORM MANUAL FLUSH WITH DOWNSTREAM VALVE CLOSED, OPEN THE FILTER FOR INSPECTION
DFU FAILED	FIRMWARE UPDATE FAIL	VALIDATE CELLULAR RECEPTION AND TRY AGAIN
OUT OF RANGE APP CONNECTION	CONTROLLER OUT OF RANGE DURING CONNECTION SESSION	GET CLOSER TO THE CONTROLLER WITH THE SMARTPHONE (WITHIN BLUETOOTH® RANGE)
SENSOR PRESSURE READ FAILED	THE NUMBER OF THE SENSOR THAT FAILED TO READ. INLET (0), OUTLET (1), PISTON (2).	IF CONTINUES - CONTACT SUPPORT
	THERE IS A VACUUM IN THE SYSTEM	PERFORM AIR RELEASE
EQUIP THE SYSTEM WITH ANTI-VACUUM VALVE		
CAPACITOR CHARGER START FAILED	UNABLE TO CHARGE CAPACITOR	CONTACT SUPPORT
LOAD CAPACITOR TIMEOUT	CAPACITOR CHARGE TIMEOUT	CHECK BATTERY VOLTAGE LEVEL, CONTACT SUPPORT
LOW DOWNSTREAM PRESSURE	THE OUTLET PRESSURE IS LESS THAN 1.5 BAR	CHECK THE FILTER AND THE WATER SYSTEM
HIGH UPSTREAM PRESSURE	THE INLET PRESSURE IS GREATER THAN MAXIMUM ALLOWED PRESSURE FOR THE FILTER	ADJUST THE WATER SYSTEM INLET PRESSURE
ANTI-FREEZE ACTIVE	FREEZING PROTECTION START, AS A RESULT OF LOW TEMPERATURE THRESHOLD	
ANTI-FREEZE EXIT	STOP FREEZING PROTECTION PROCEDURE	

Netafim Limited Warranty

1. This certificate applies to Netafim Ltd. («Netafim») products purchased by you (the «Buyer») from Netafim unless specifically agreed otherwise in writing by Netafim. This Warranty extends only to the original purchaser, and is not transferable to anyone who subsequently purchases, leases, or otherwise obtains the product from the original purchaser.
2. Netafim hereby warrants that the products are and will be free from defects in material and workmanship under normal use and service. Netafim warrants that it will correct manufacturing defects in the products, in accordance with the conditions set out in this Warranty.
3. This Warranty is enforceable for a period of 12 months after the date upon which the products were delivered (the "Warranty Period").
4. In the event that during the Warranty Period the Buyer discovers a defect in material and/or workmanship in any product or part (the "Defective Product"), it shall submit a written complaint to Netafim using Netafim's standard Buyer Complaint Form. For the receipt of the Buyer Complaint Form, the submission of the complaint or any questions please contact your service representative.
5. Upon written demand by Netafim the Buyer shall return the Defective Product - or a sample thereof - to Netafim, at Netafim's cost. If the Buyer ships any such Defective Product, Netafim suggests the Buyer package it securely and insure it for value, as Netafim assumes no liability for any loss or damage occurring during shipment. Provided however that in the event Netafim determines that this Warranty does not apply to such product, Buyer shall promptly reimburse Netafim for such cost (including freight and customs). Any returned product or part must be accompanied by the Warranty certificate and the purchase invoice. It is clarified that the Buyer may not return the Defective Product unless such return was coordinated and approved by Netafim in advance.
6. Netafim's obligation under this Warranty shall be limited to, at Netafim's option, the repair or exchange, free of charge, of the product or any part which may prove defective under normal use and service during the Warranty Period. The provision of a repair or replacement of a product during the Warranty Period will result in an extension of the Warranty Period by an additional period of 12 months, provided that the total accumulated Warranty Period shall in any event be no more than 18 months from the date upon which the products were delivered.
7. This Warranty is valid on the condition that the products are installed according to Netafim's instructions as expressed in Netafim's instruction manuals and according to the technical limitations as stipulated in Netafim's literature or as stated by a representative of Netafim.
8. This Warranty will not apply to damaged or defective products resulting from or related to:
 - (i) Fire, flood, power surges or failures or any other catastrophe and/or unforeseen occurrence, such as but not limited to those for which the Buyer is customarily insured for, or any force majeure events;
 - (ii) Fault, abuse, or negligence of the Buyer;
 - (iii) Intake water not meeting the agreed standards, as set forth in a written document, approved by Netafim, or improper storage;
 - (iv) Improper or unauthorized use of the product or related parts by the Buyer, including Buyer's failure to operate the product in conformity with the recommendations and instructions of Netafim, as set forth in Netafim's manuals and other written materials, the operation of the product other than by a trained and qualified operator, or improper installation of the product by a third party not authorized by Netafim;
 - (v) Performance by the Buyer of maintenance or operation other than in conformity with the recommendations and instructions of Netafim, or other than in accordance with procedures defined in the literature supplied for products (including the timely replacement of requisite parts), and for services provided other than by a trained and qualified advanced operator; or
 - (vi) Any alteration, modification, foreign attachment to or repair of the products, other than by Netafim or its authorized technical representatives.
9. In no event shall Netafim be liable to the Buyer or any third party for any damages to property, or for any intangible or economic loss, including loss of profits, loss of customers or damage to reputation, for any damages, including indirect, special, consequential damages, or punitive damage arising out of or in connection with this Warranty, or arising out of or in connection with the product's performance or failure to perform, even if it has been advised of the possibility of such damages.
10. Netafim will be excused for failure to perform or for delay in performance hereunder if such failure or delay is due to causes beyond its reasonable control or force majeure preventing or hindering performance.
11. This Warranty set forth herein is the only contractual warranty given by Netafim and is provided in lieu of any other warranties created by any documentation, packaging or otherwise.
12. Netafim makes no warranty whatsoever in respect to accessories or parts not supplied by Netafim. In the event that Netafim is required to correct a Defective Product or product not covered by this Warranty, it will do so solely in consideration for additional fees.
13. The parties will actively endeavor to amicably settle any dispute arising between them. In the event that the parties are unable to reach an equitable settlement of such dispute, any claim or lawsuit related to the Warranty, its validity execution, its performance be brought before only the courts of Tel-Aviv, Israel. Israeli law will govern the Warranty, to the exclusion of any conflict of law rules.



Manufacturer
Amiad Water Systems Ltd.
D.N. Galil Elyon 1, 1233500, Israel.
Tel: +972 4690 9500 | Fax: +972 48141159 | Email: info@amiad.com

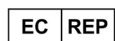

European Authorised Representative for CE
Obelis s.a. Bd Général Wahis 53, 1030 Brussels, Belgium.
Tel: +(32) 2732 5954 | Fax: +(32) 27326003 | Email: mail@obelis.net

EU Declaration of Conformity <https://www.amiad.com/certificatesDownload.asp>

The Bluetooth® word mark and logos are registered trademarks owned by the Bluetooth SIG, Inc. and any use of such marks by Netafim is under license. Other trademarks and trade names are those of their respective owners.



01-0920-ALPHA-PUG-001-EN

GROW MORE WITH LESS™



www.netafim.com