

SANDSTORM™

METAL SINGLE-CHAMBER MEDIA FILTER

INSTALLATION MANUAL

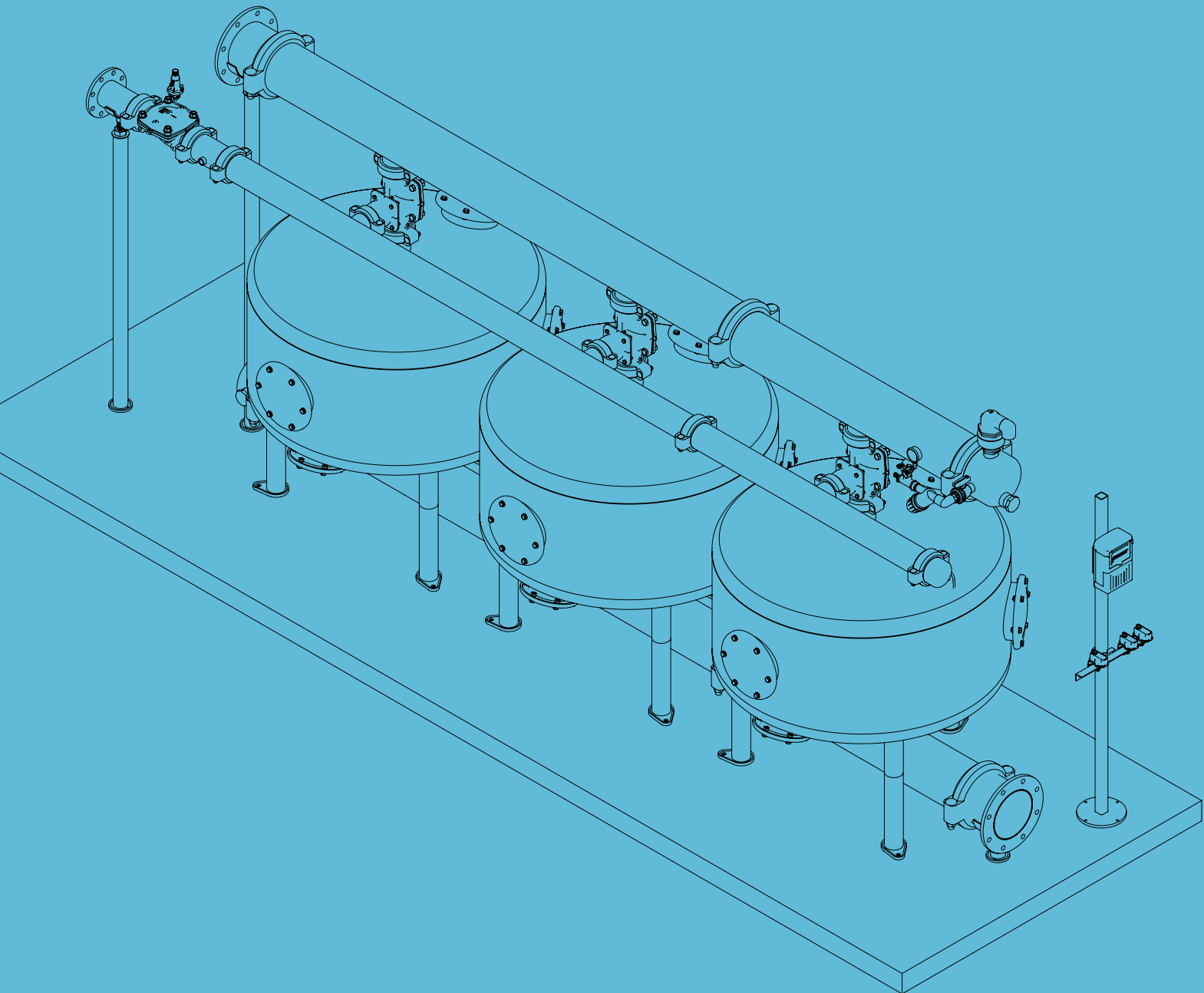

CONTENTS

Introduction

Aim of this manual	3
Safety instructions	3
General instructions	4
Components and structure	4
On-site pre-installation preparations	5
Tools required for installation	6
Flange connection	6
Grooved coupling connection	7

Installation

Install add-ons (optional)	19
----------------------------	----

Initial operation

Troubleshooting

Warranty

© COPYRIGHT 2018, NETAFIM™

NO PARTS OF THIS PUBLICATION MAY BE REPRODUCED, STORED IN AN AUTOMATED DATA FILE OR MADE PUBLIC IN ANY FORM OR BY ANY MEANS, WHETHER ELECTRONIC, MECHANICAL, BY PHOTOCOPYING, RECORDING OR IN ANY OTHER MANNER WITHOUT PRIOR WRITTEN PERMISSION OF THE PUBLISHER.

ALTHOUGH NETAFIM™ TAKES THE GREATEST POSSIBLE CARE IN DESIGNING AND PRODUCING BOTH ITS PRODUCTS AND THE ASSOCIATED DOCUMENTATION, THEY MAY STILL INCLUDE FAULTS.

NETAFIM™ WILL NOT ACCEPT RESPONSIBILITY FOR DAMAGE RESULTING FROM THE USE OF NETAFIM'S PRODUCTS OR THE USE OF THIS MANUAL.

NETAFIM™ RESERVES THE RIGHT TO MAKE CHANGES AND IMPROVEMENTS TO ITS PRODUCTS AND/OR THE ASSOCIATED DOCUMENTATION WITHOUT PRIOR NOTICE.



FOREIGN LANGUAGES

In the event that you are reading this manual in a language other than English, you hereby acknowledge and agree that the English language version shall prevail in case of inconsistency or contradiction in interpretation or translation.

INTRODUCTION

Aim of this manual

The aim of this manual is to provide the technician with general instructions for the installation of any configuration of the SandStorm™ metal single-chamber sand filtration system.

All system components are shipped to the site packed in pallets and boxes with installation drawings, user manual, and a packing list.



NOTE

This manual describes the generic installation process of a SandStorm™ filtration system. The installation should be carried out in line with the installation drawings supplied with the system.

Safety instructions

Before handling any part of the system, carefully read the instructions and act accordingly.



NOTE

The maximum working pressure of the filtration system is 8 bar (116 PSI).
(For filtration systems made to order, see the maximum working pressure in the Product Order).

Check and make sure the pumps and valves do not exceed the tolerances of the system and match the requirements of the system pressure and flow-rate specifications (see the documentation supplied with the system).



WARNING

Do not perform installation or maintenance operations or open filter ports before the pressure in the system is fully released. For draining purposes, open any valve downstream from the filtration system until the pressure is fully released. Check the pressure gauge to be sure it is at 0 before proceeding.



TIP

If a valve downstream from the filtration system is not available for pressure release, you can install a manual valve on the lower 2" socket of the outlet manifold end-cap.

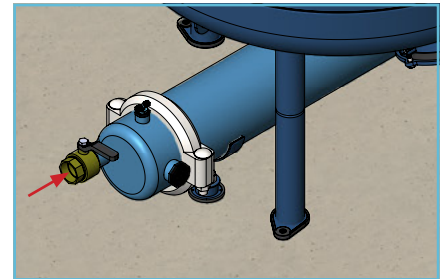

Electrical connections and wiring must be done by an authorized electrician only.

Be sure that prior to any maintenance procedures, all electrical connections to the system are unplugged (AC controller, pumps, etc.).

Work only with proper and standard tools (see [Tools required for installation](#), page 6).

Use only original parts supplied/approved by Netafim™.

INTRODUCTION

General instructions

- Installation must be performed by experienced and knowledgeable technicians.
- Consult with your supervisor if problems occur during installation.
- Do not apply excessive force or pressure on components during installation.

Electricity

- AC controller only: Ensure that a suitable electrical power supply is available in the vicinity of the installation for electrical connection of the controller (see [Electricity connection](#), page 5).
- An additional electrical socket should be available at the installation site, for installation and service.

Components and structure

A media filtration system is comprised of the following components:

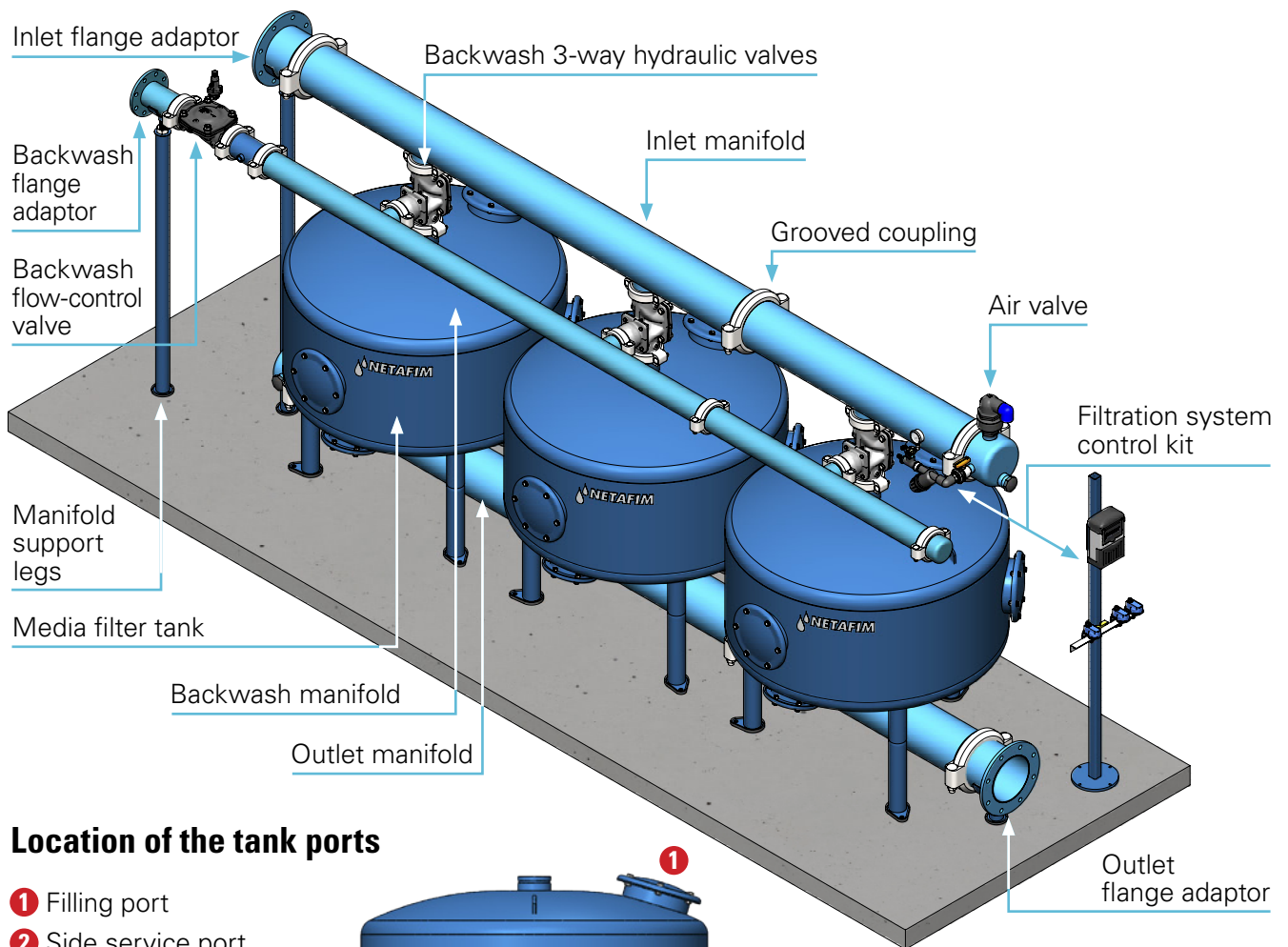

Location of the tank ports

- 1 Filling port
- 2 Side service port
- 3 Bottom service port

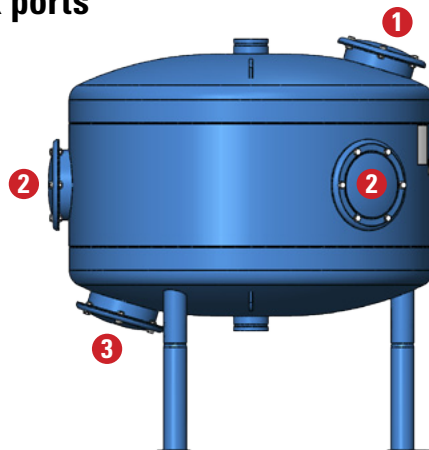

INTRODUCTION

On-site pre-installation preparations

The following items should be set up on site before the installation of the filtration system.

Electricity connection

The BackFlush controller is supplied in either of two versions:

- 100-240v AC input - powered by an external 100-240v AC to 12v DC power supply.
Requires mains electricity supply - 100-240v AC ~, 50/60 Hz 0.4 A Max.
Ensure that suitable electrical power supply is available in the vicinity of the BackFlush controller
A readily accessible circuit breaker, rated according to the BackFlush controller's total rated power for peak demand, certified as a branch circuit over current protector, compliant with the national code and requirements. Grounding connection: $\leq 10 \Omega$.
- 6v DC input - powered by 4 x 1.5v D-size alkaline batteries (not supplied).
Does not require mains electricity supply.



NOTE

If the filtration system was not ordered with a BackFlush controller and is intended to be connected to an existing irrigation system controller, see the irrigation controller user manual for instructions.

Concrete slab construction

The sand filtration system will weigh anywhere from 250 kg up to a few tons. The system foundation must take into consideration the total weight of the system when filled with sand and water.

The media filtration system should be installed on a concrete slab, at least 10 cm thick, with proper reinforcement and anchored to the ground.

The dimensions given in the table on the right are the **external filtration system dimensions** and not the concrete slab dimensions

The minimum slab dimensions should allow a sufficient margin around the filtration system for service and maintenance.

The slab should have a slight grade to allow for water run-off, but not so great that the manifold does not bolt together easily.

The soil all around the slab should be compacted to prevent erosion.

Straight-line filtration systems*

No. of tanks	External filtration system dimensions (length/width/height)		Total system weight**	
	cm	inch	kg	lbs

30" tanks

2	329/83/212	130/33/84	1000	2204
3	449/83/212	177/33/84	1500	3307
4	569/83/212	224/33/84	2000	4409
5	689/83/212	271/33/84	2500	5512

36" tanks

2	329/92/219	130/36/86	1600	3527
3	449/92/219	177/36/86	2400	5291
4	569/92/219	224/36/86	3200	7055
5	689/92/219	271/36/86	4000	8819

48" tanks

2	356/128/221	140/50/87	2600	5732
3	488/128/221	192/50/87	3900	8598
4	620/128/221	244/50/87	5200	11464
5	752/128/221	296/50/87	6500	14330

*For other filtration system configurations, contact your local Netafim™ representative.

**Filled with sand and water

INTRODUCTION

Backwash pipe

A pipe is necessary to take the backwash water from the backwash manifold back to the water source (comply with your local regulations) or to the closest drainage ditch.

In order not to limit backwash flow rate:

- The backwash pipe should be no longer than 20 m (65 ft).
- The pipe diameter should never be smaller than the backwash manifold diameter.
- If the backwash pipe length is 10 meters (33 ft) or less, it should be of the same diameter as the backwash manifold.
- If the backwash pipe is longer than 10 meters (33 ft), it should be of a larger diameter than the backwash manifold.
- The pipe should not ascend above the elevation of the flushing manifold outlet.

Tools required for installation

- No special tools are needed. A standard full installer toolkit is adequate.
- To connect the control stand to the concrete slab: An electrical hammering drill and a concrete drill bit.
- To connect grooved couplings: The following wrenches are required:

Grooved coupling size		Bolt and nut size (mm)	Wrench size (mm)
inch	mm		
2	50	M10	17
3	80	M12	19
4	100	M12	19
6	150	M16	24
8	200	M20	30
10	250	M22	34

- To connect flanges: The following wrenches are required:

Flange size	Bolt and nut size	Wrench size
up to 8"	5/8"	15/16"
10" to 14"	7/8"	1.1/8"

Flange connection

In most cases, the filtration system manifolds are connected to the main line with flanges.



ATTENTION

When connecting flange pipe connectors, do not forget to place the rubber gasket in place.

INTRODUCTION

Grooved coupling connection

All the main filtration system parts are connected with grooved couplings.

To connect a grooved coupling:

- a.** Slide the rubber gasket onto the end of one of the pipes to be connected.

Apply a dedicated lubricant or liquid soap to the coupling rubber gasket to facilitate insertion.

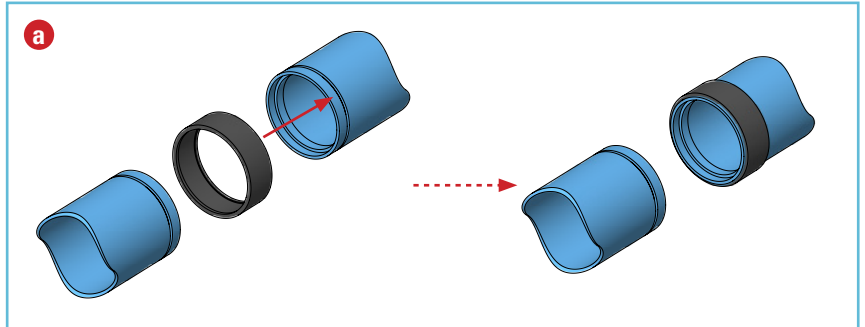

- b.** Place the end of the other pipe to be connected so that it touches the end of the first pipe, and slide the rubber gasket over the end of the second pipe. The rubber gasket should cover the end of both pipes equally, leaving the groove of each pipe exposed.

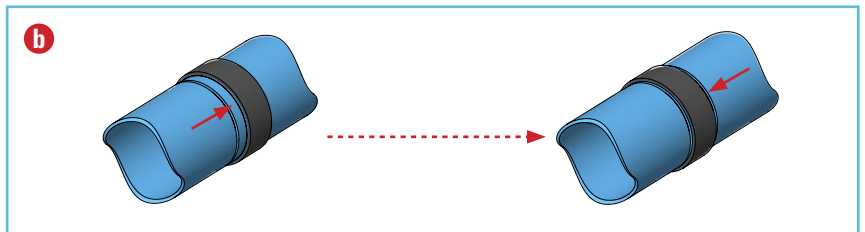

- c.** Place the two housing elements around the rubber gasket. Make sure the rims of the housing elements are inserted into the grooves all around both pipes.

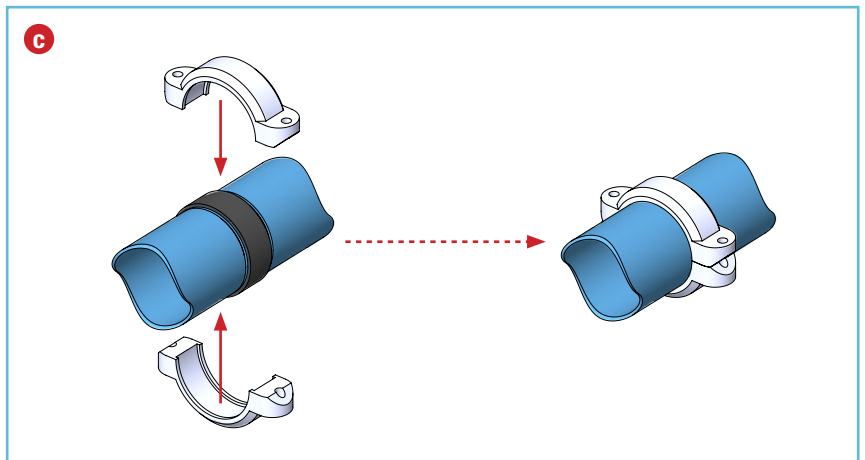

- d.** Put the bolts and nuts in place and close them to a tight fit, but do not fasten them yet.

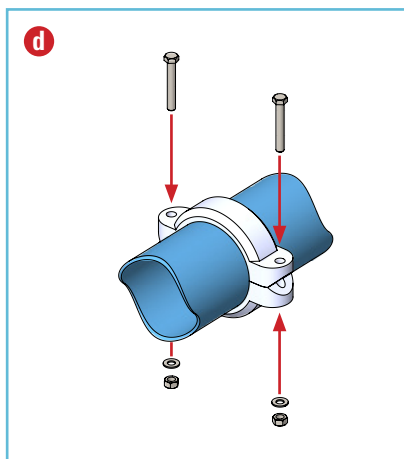

- e.** When you are satisfied that the connected parts are properly positioned and the connections are properly aligned, fasten the two nuts alternately until the coupling is evenly tightened around both pipes.

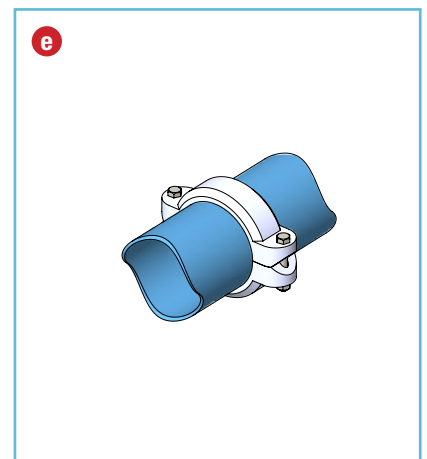

INSTALLATION

This chapter describes the generic installation process of a SandStorm™ filtration system. The installation should be carried out in line with the installation drawings supplied with the system.

1. Align the gravel tanks on the platform according to the dimensions in the following table

Tank size (inch)	Distance between tanks - center to center* (a)	
	cm	inch
30"	120	47.24
36"	120	47.24
48"	132	51.97

*The distances in this table are for straight-line systems. For the distance between adjacent rows of tanks in other system configurations, see the installation drawings supplied with the system.

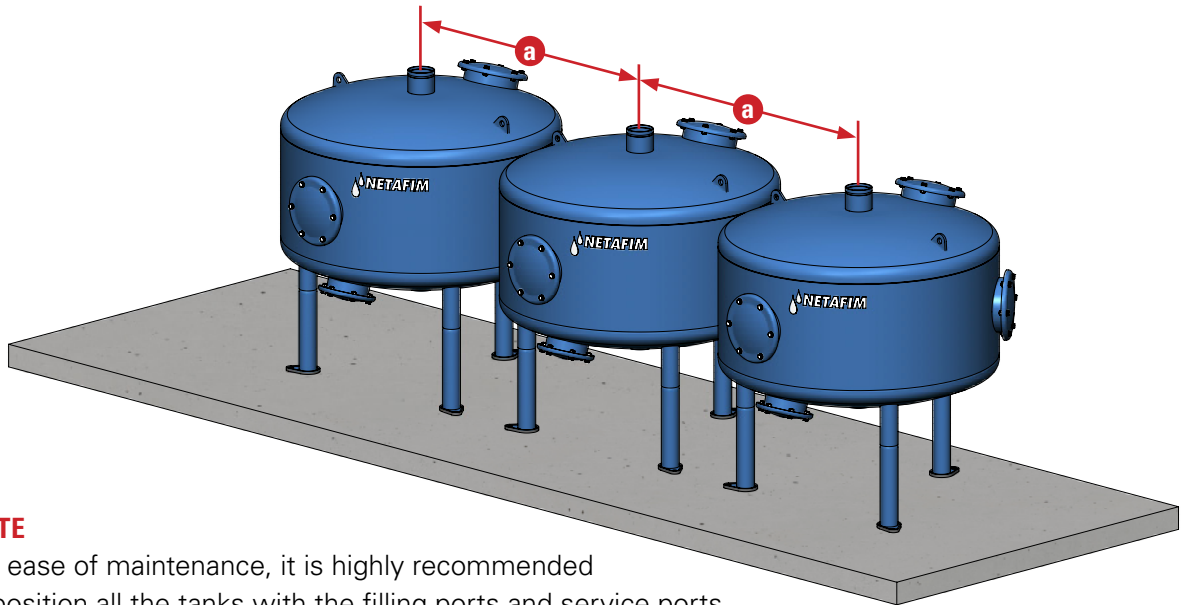

NOTE

For ease of maintenance, it is highly recommended to position all the tanks with the filling ports and service ports, respectively, pointing in the same direction.

2. Connect a backwash valve to each tank inlet with a grooved coupling (see the [Grooved coupling connection](#) instructions, page 7). Be sure that the position of the backwash valves is per the flow arrows marked on the valve.

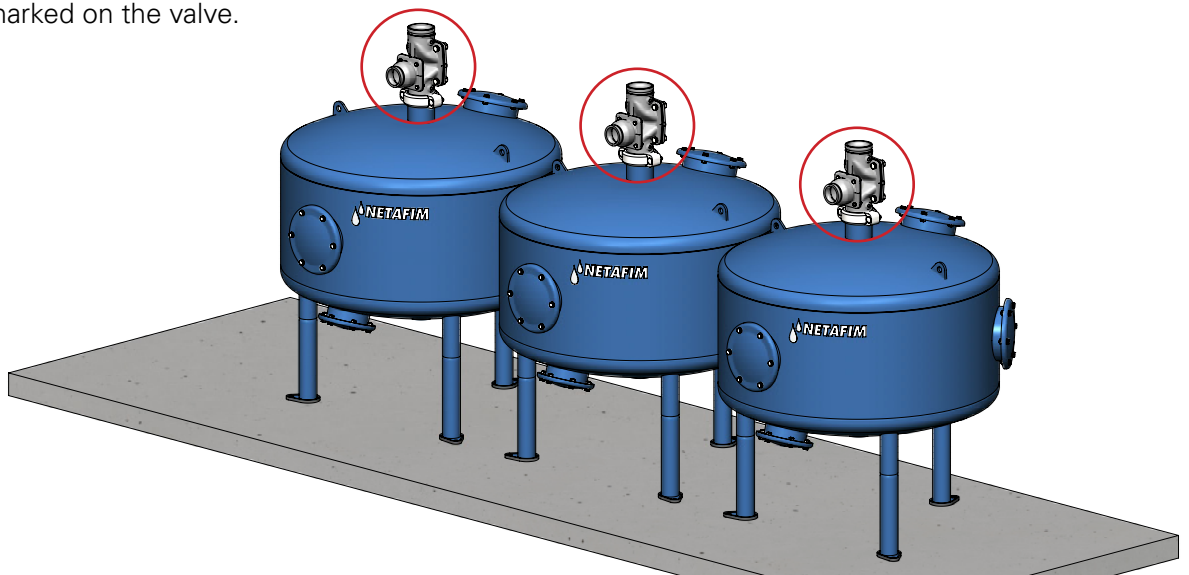

INSTALLATION



NOTE

The manifolds are supported by support leg. Each support leg should be installed immediately after installing the part it supports. Place the support legs according to their quantity and locations in the system installation drawings. Use the long support legs to support the inlet manifold, the medium legs to support the backwash manifold and the short legs to support the outlet manifold.

3. Connect the inlet manifold to the backwash valves and the inlet manifold sections to each other with grooved couplings.

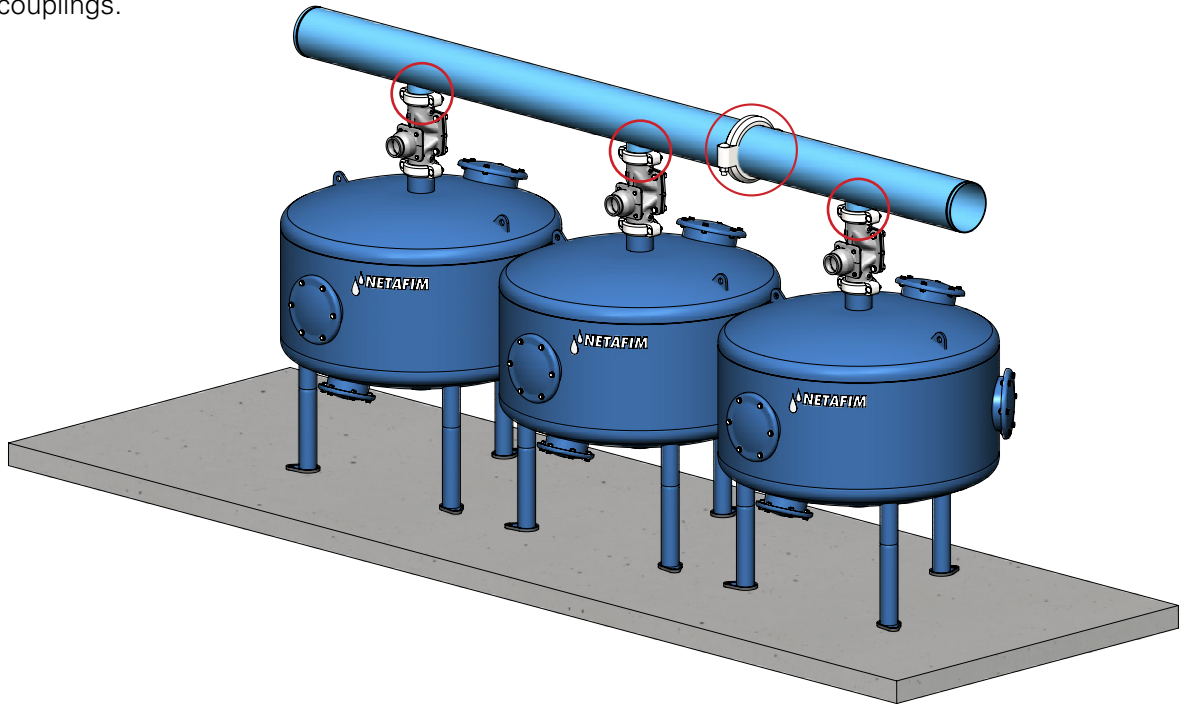

4. Connect the backwash manifold to the backwash valves and the backwash manifold sections to each other with grooved couplings.

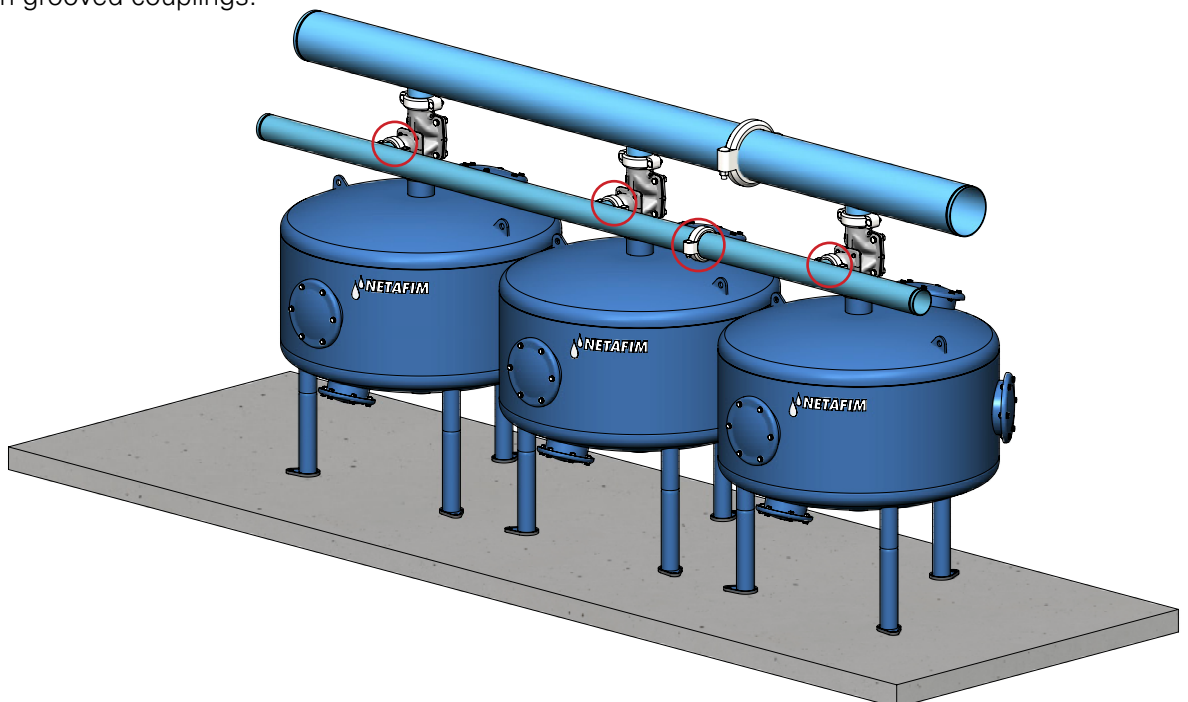

INSTALLATION

5. Connect the outlet manifold to the outlets of the tanks and the outlet manifold sections to each other with grooved couplings.

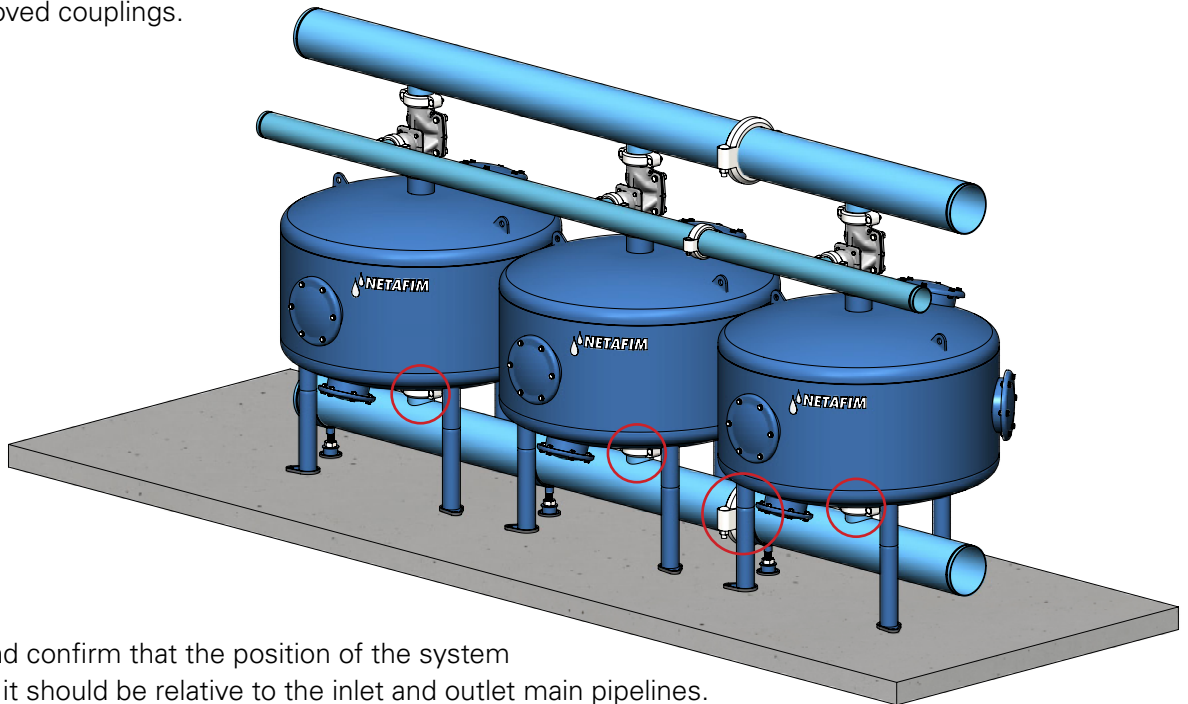

6. Check and confirm that the position of the system is where it should be relative to the inlet and outlet main pipelines. Readjust the filtration system location if needed.

7. Connect the backwash flow-control valve:

- If the backwash flow-control valve is a manual valve:
 - a. Connect the flange adaptor to the outlet of the backwash manifold with a grooved coupling.
 - b. Connect the backwash flow-control valve to the flange adaptor.
- If the backwash flow-control valve is a hydraulic valve:
 - a. Connect the dedicated backwash manifold short section (equipped with the outlet for the valve-command water-supply assembly) to the outlet of the backwash manifold with a grooved coupling.

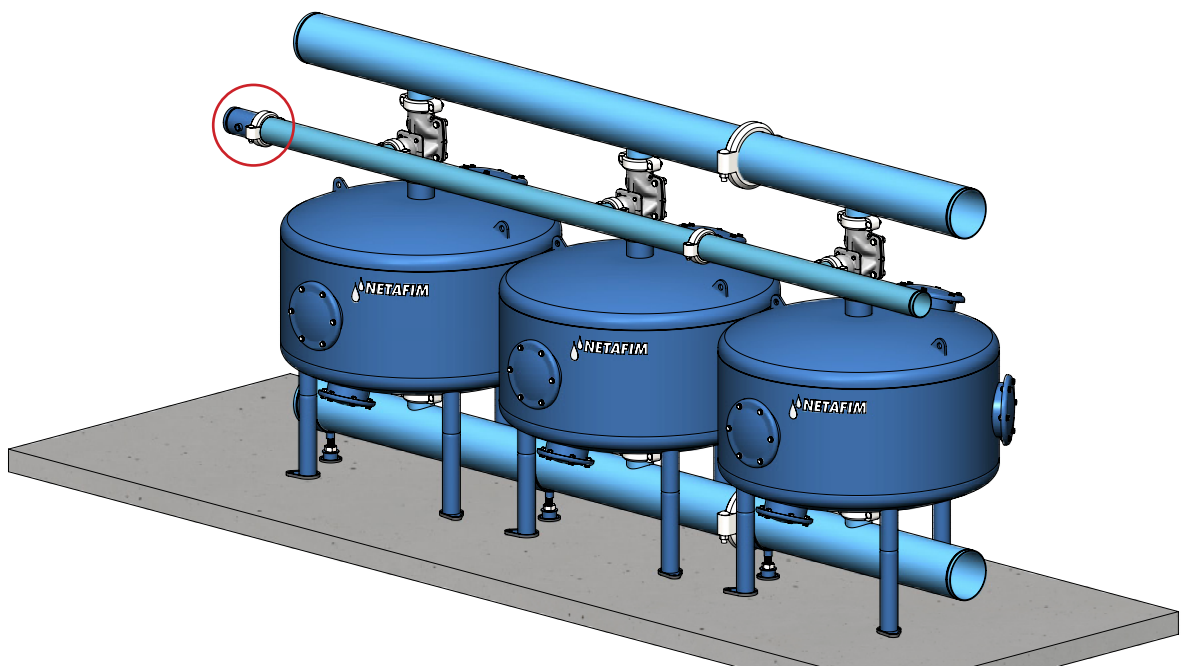

INSTALLATION

- b.** Connect the backwash flow-control valve to the backwash manifold's short section with a grooved coupling. Be sure that the position of the valve is per the flow arrow marked on the valve.

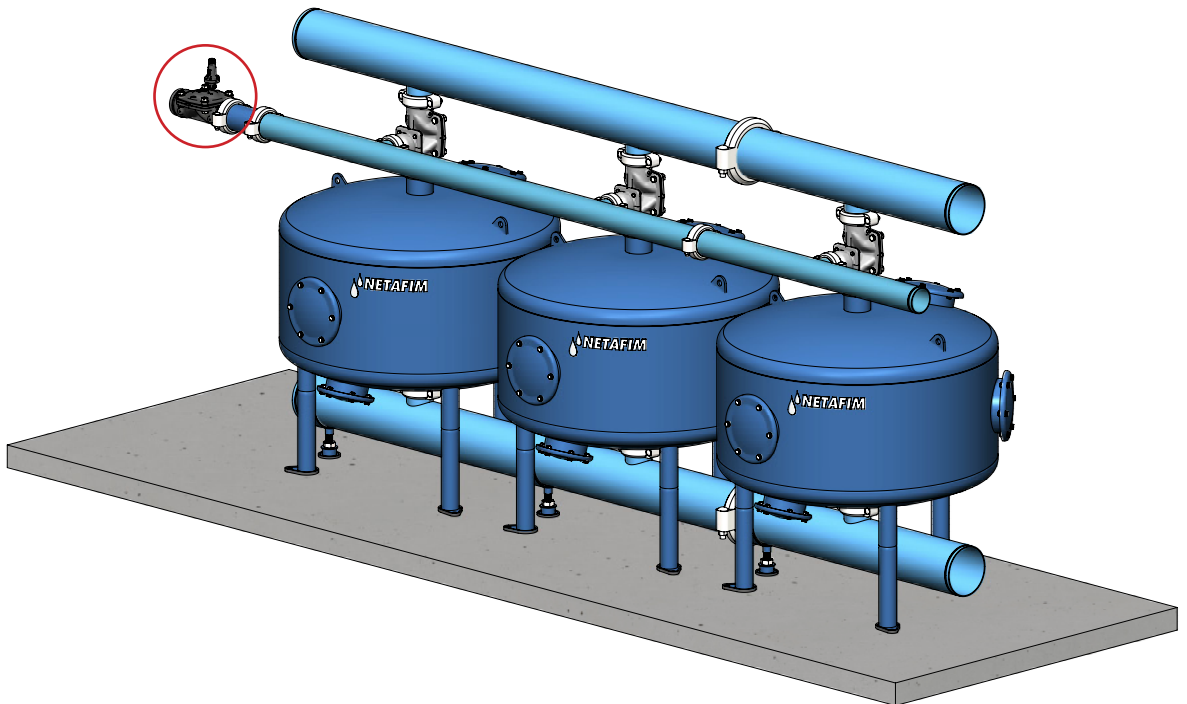

- c.** Connect the valve-command water-supply assembly to the dedicated outlet of the backwash manifold short section.



ATTENTION

Cut the PE 8 mm command tubes to the required length. To avoid kinks, the PE 8 mm command tubes should be of the right length to form regular curves.

- d.** Connect a PE 8 mm command tube from the high pressure point of the valve to the valve-command water-supply assembly.
- e.** Connect a PE 8 mm command tube from the high pressure point of the pilot to the valve-command water-supply assembly.
- f.** The valve is supplied with the suitable orifice plate for the specific filtration system. Before installing the valve, make sure that the orifice plate is in its place inside the valve inlet.

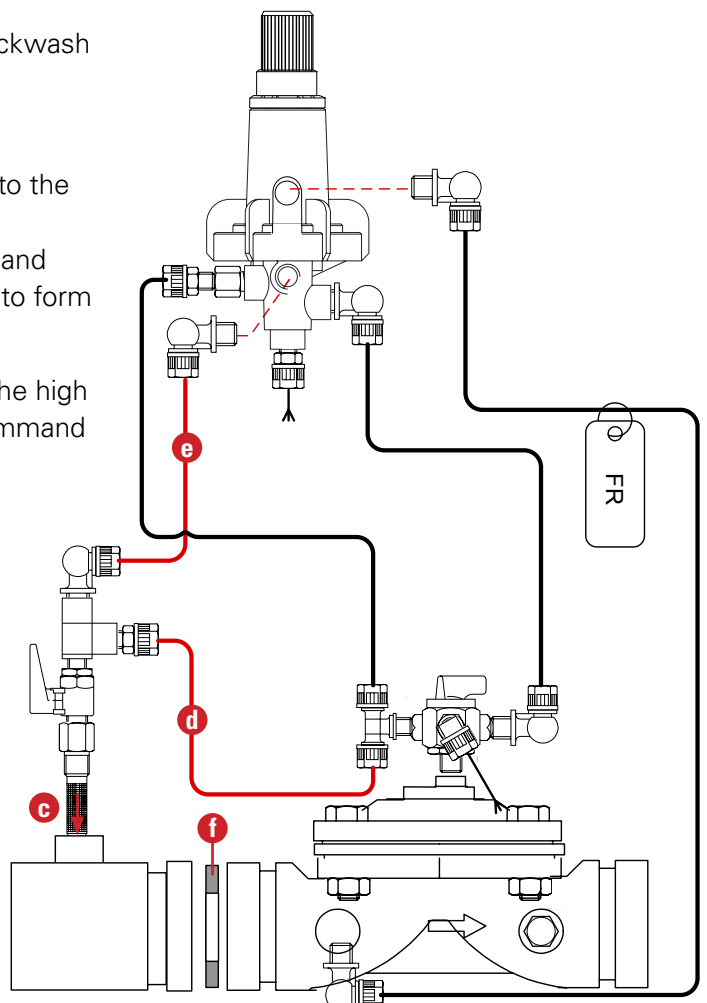

INSTALLATION

8. Connect the end-cap to the backwash manifold with a grooved coupling.

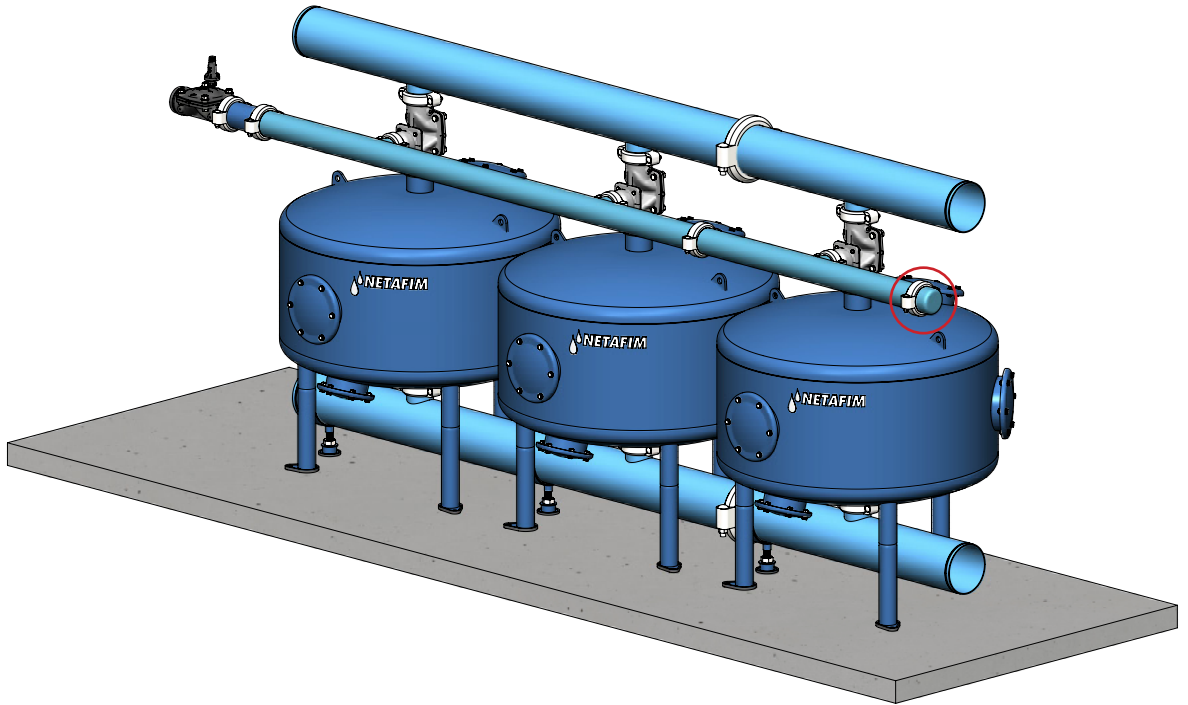

9. Connect the end-cap to the inlet manifold with a grooved coupling. Make sure that the end-cap is placed with the socket for the air valve pointing upwards and the socket for the control assembly pointing sideways.

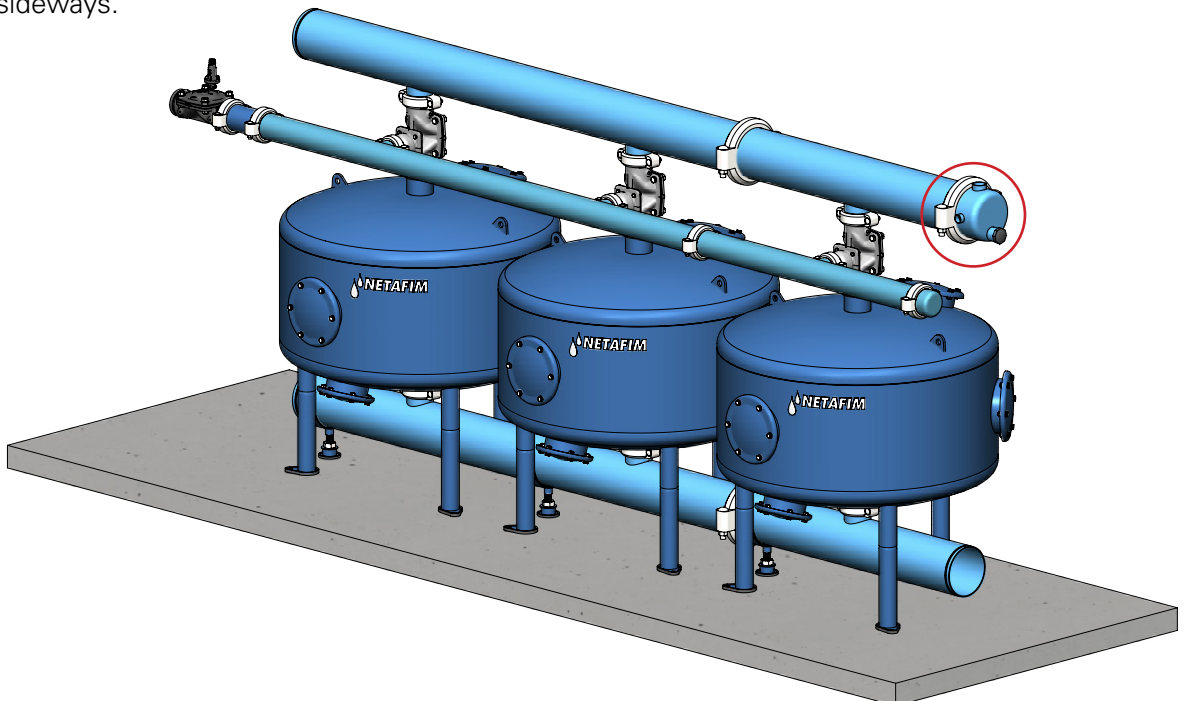

INSTALLATION

10. Connect the end-cap to the outlet manifold with a grooved coupling. Make sure that the end-cap is placed with the 1" outlet pointing upwards.

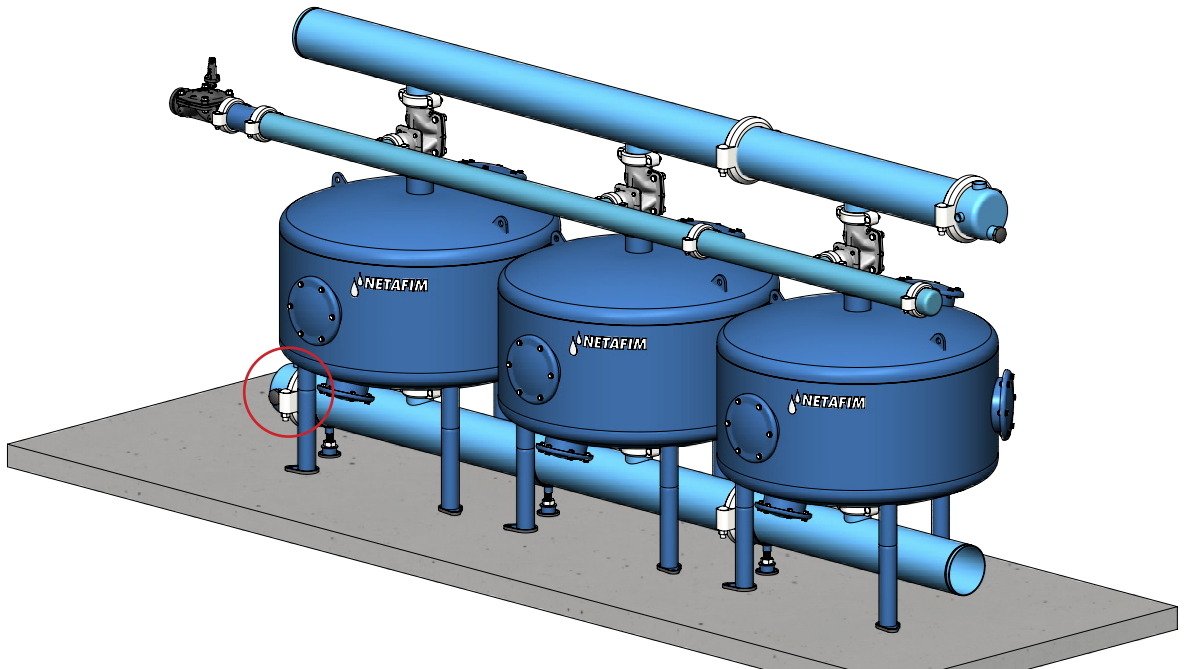

NOTE

The filtration system is supplied with flange adaptors for its connection to the main line and backwash pipe. Some installations do not require flange adaptors since the main line and backwash pipes comply with the grooved coupling standard. In such cases, skip steps 10 and 11 below. Simply connect the filtration system to the main line and backwash pipe with grooved couplings.

11. Connect the flange adaptors to the inlet and outlet manifolds with grooved couplings.

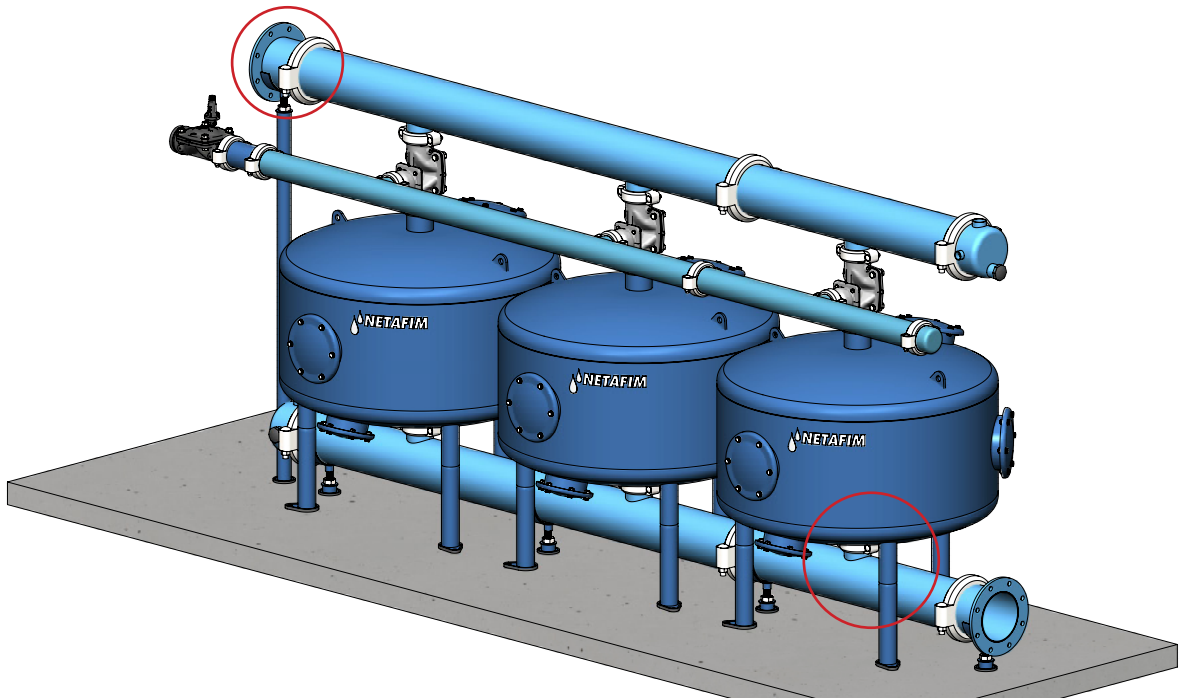

NOTE

If the filtration system is supplied with an inlet adaptor pipe (ordered separately), connect the inlet adaptor pipe to the inlet manifold with a grooved coupling and then connect the flange adaptors to the inlet adaptor pipe with a grooved coupling.

INSTALLATION

12. Connect the flange adaptor to the backwash flow-control valve with a grooved coupling.

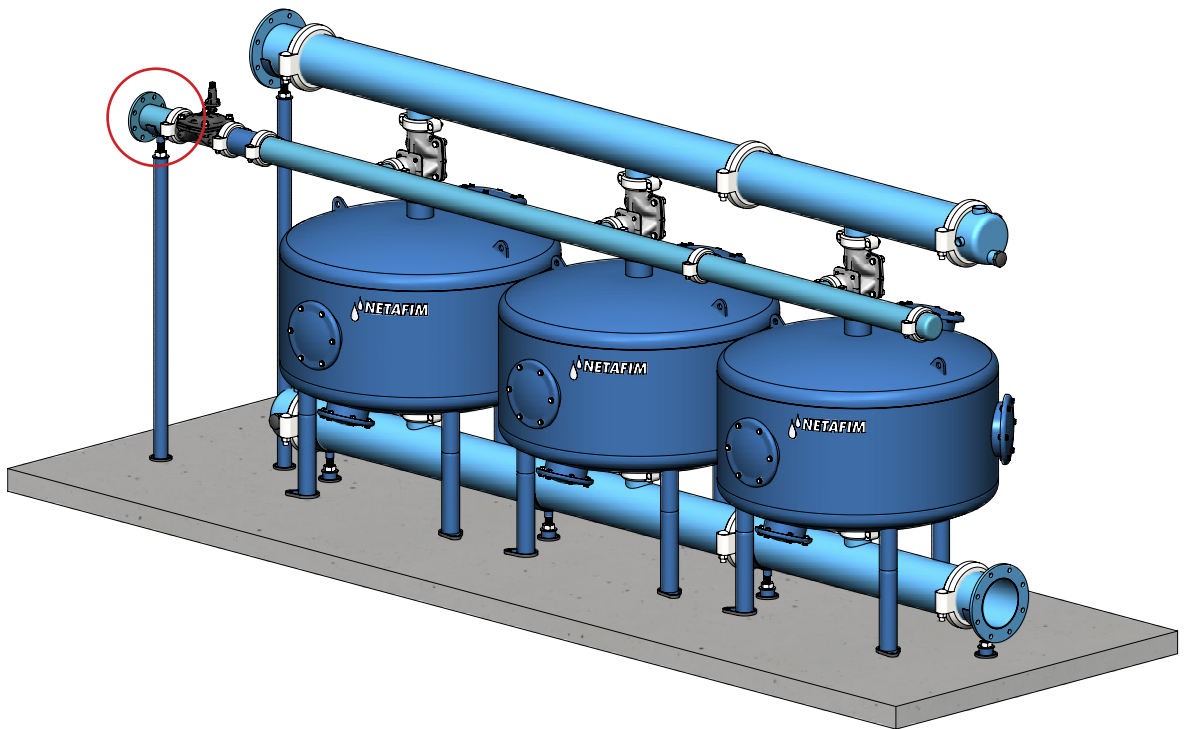

13. Make sure that all the grooved coupling connections are properly aligned.
14. Fasten all the grooved couplings. Fasten the two nuts of each grooved coupling alternately until the coupling is evenly tightened around both pipes (see [Grooved coupling connection](#), page 7)
15. Connect the air valve to the socket on the top of the inlet manifold end-cap.

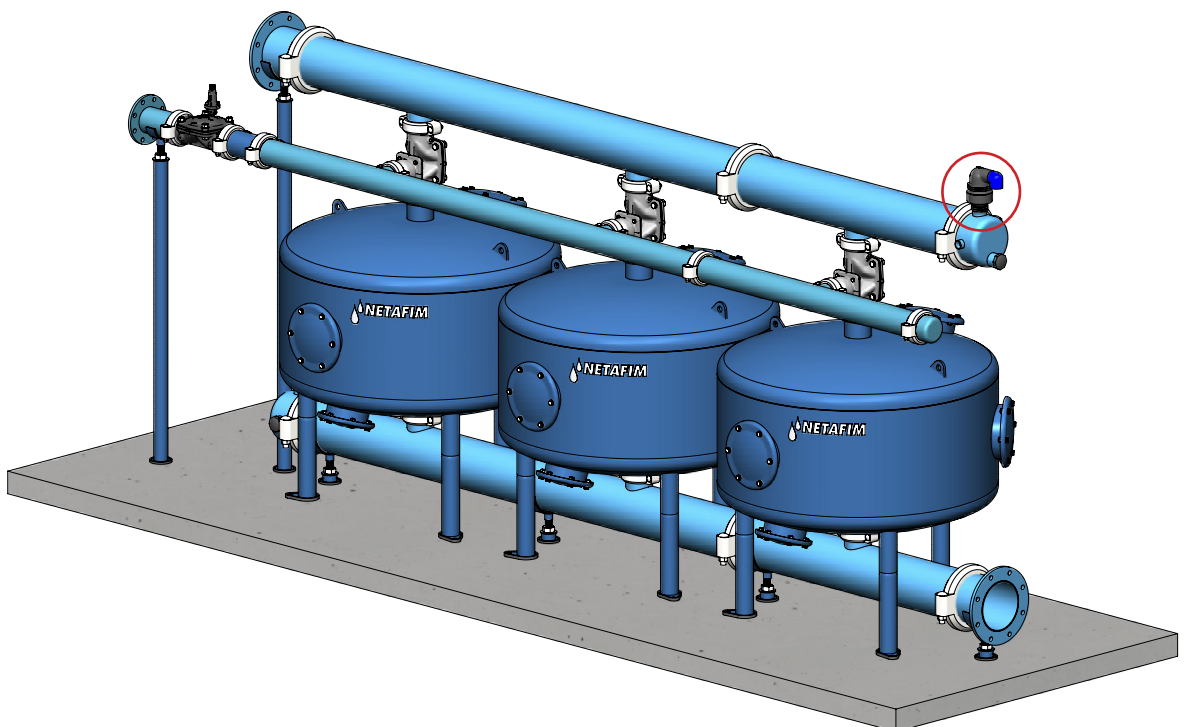

INSTALLATION

16. Connect the control assembly to the socket on the side of the inlet manifold end-cap.

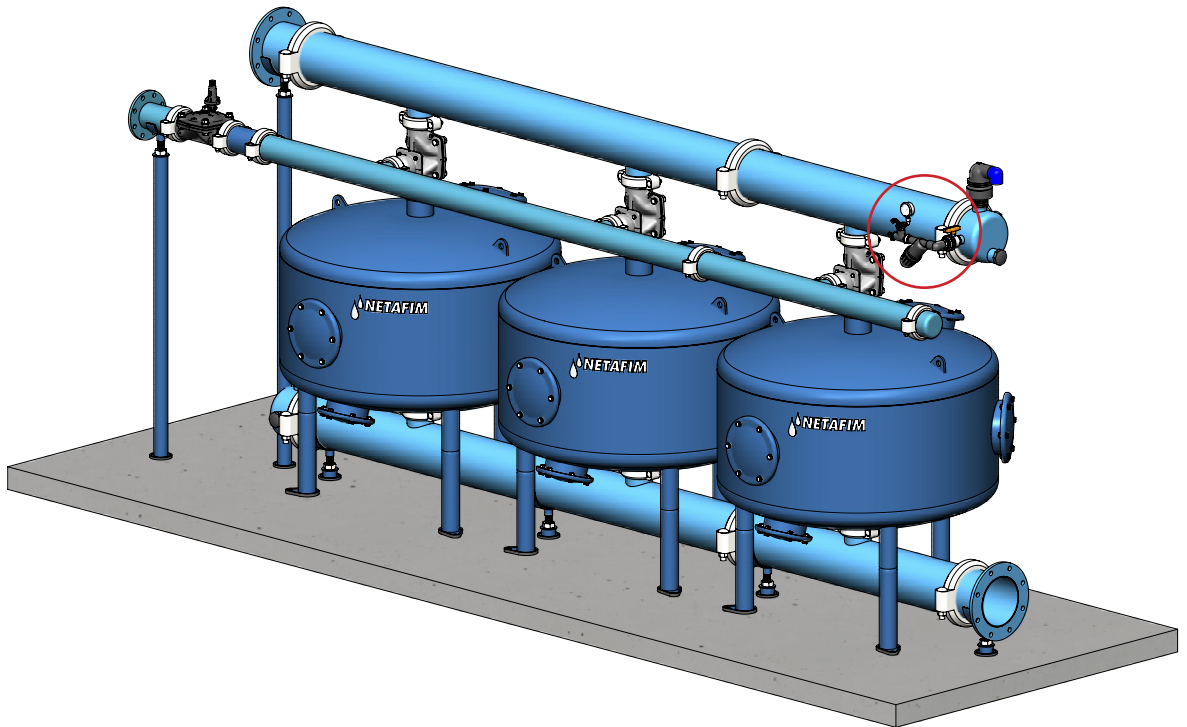

17. Place the stand of the backwash controller so that it is close to the control assembly (make sure it meets your needs for both operation and maintenance). Secure it to the concrete slab with 10 mm spreading anchor bolts.

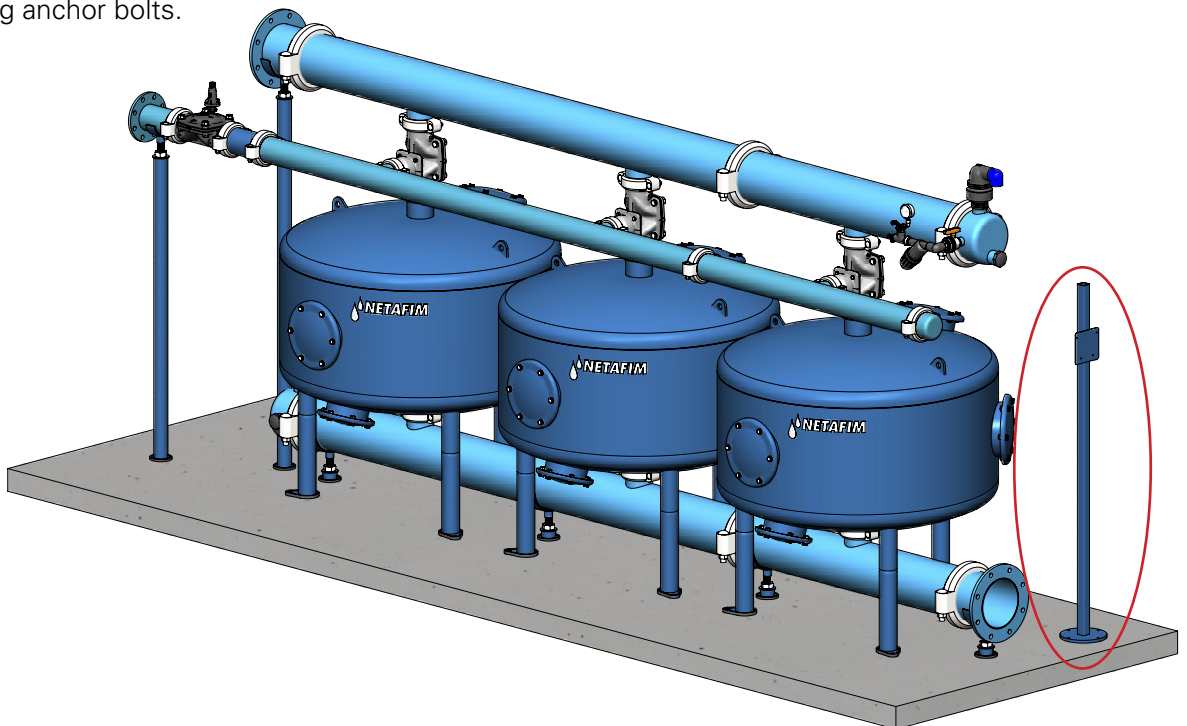

NOTE

There are 2 solenoid placement options:

A. All the solenoids are placed on the solenoid bracket on the controller stand.

B. Each solenoid is placed on its respective backwash valve.

Perform steps 18 and 19 below according to the planned solenoid location.

INSTALLATION

A. All the solenoids are placed on the solenoid bracket on the controller stand:

18. Secure the BackFlush controller and the solenoid bracket in place on the stand.

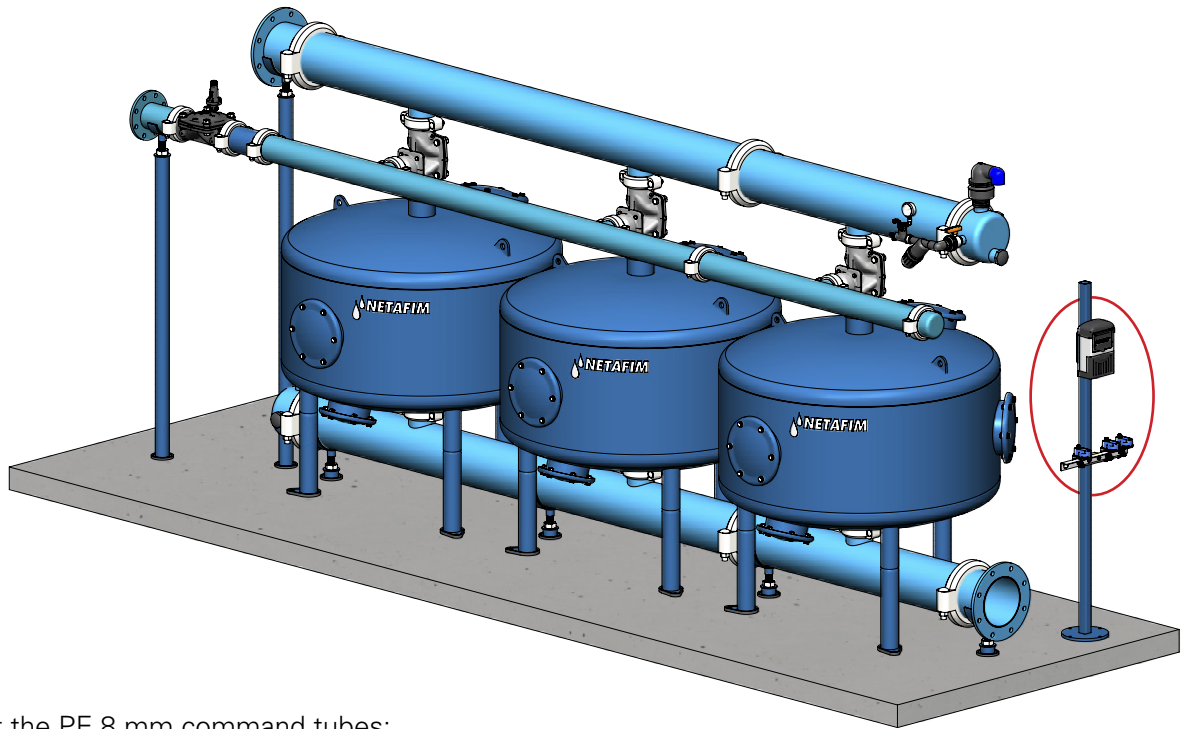

19. Connect the PE 8 mm command tubes:

- a. From the low pressure point in the BackFlush controller to the low pressure point socket on the end cap of the outlet manifold of the gravel filtration system (find the accessories in the control kit).
- b. From one of the outlets on the 3-way ball valve of the control kit to the low pressure point socket on the end cap of the outlet manifold (find the accessories in the control kit).
- c. From the outlet of the water control kit to the common "live pressure" inlets of the solenoids.
- d. From the outlet of the water control kit to the high pressure point of the BackFlush controller.
- e. From each solenoid command outlet to one of the hydraulic backwash valves, in order of sequence.
- f. Connect a drain tube (no more than 2 meters) to the common vent of the solenoids.
- g. Secure the PE 8 mm command tubes with plastic zip ties in an organized and tidy fashion along the filtration system.

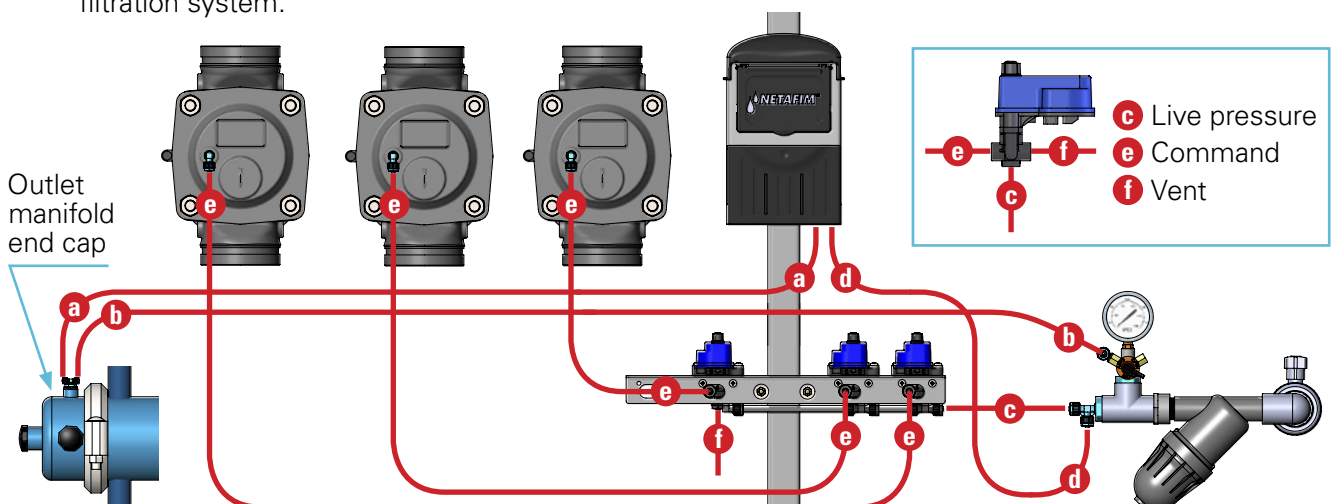

INSTALLATION

B. Each solenoid is placed on its respective backwash valve:

18. Secure the BackFlush controller in place on the stand.

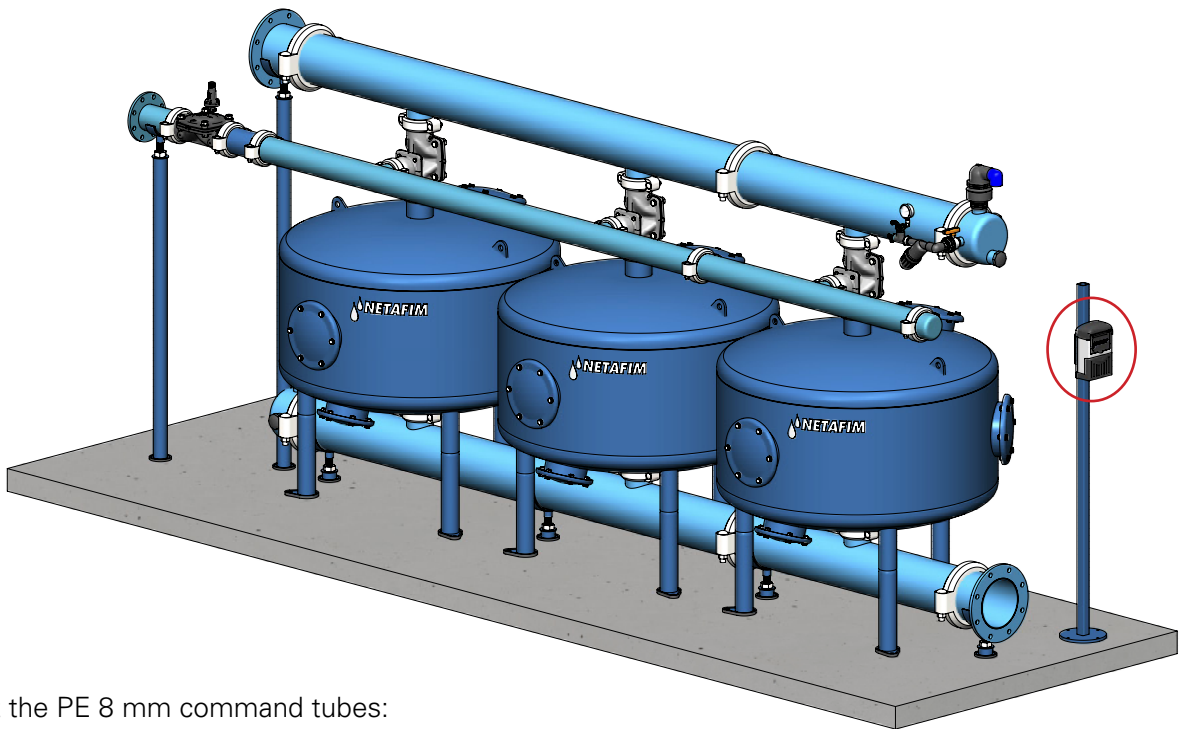

19. Connect the PE 8 mm command tubes:

- From the low pressure point in the BackFlush controller to the low pressure point socket on the end cap of the outlet manifold of the gravel filtration system (find the accessories in the control kit).
- From one of the outlets on the 3-way ball valve of the control kit to the low pressure point socket on the end cap of the outlet manifold (find the accessories in the control kit).
- From the outlet of the water control kit, concatenate to the common "live pressure" inlets of all the solenoids.
- From the outlet of the water control kit to the high pressure point of the BackFlush controller.
- From each solenoid command outlet to its hydraulic backwash valve.
- Connect a drain tube (no more than 2 meters) to the common vent of each solenoid.
- Secure the PE 8 mm command tubes with plastic zip ties in an organized and tidy fashion along the filtration system.

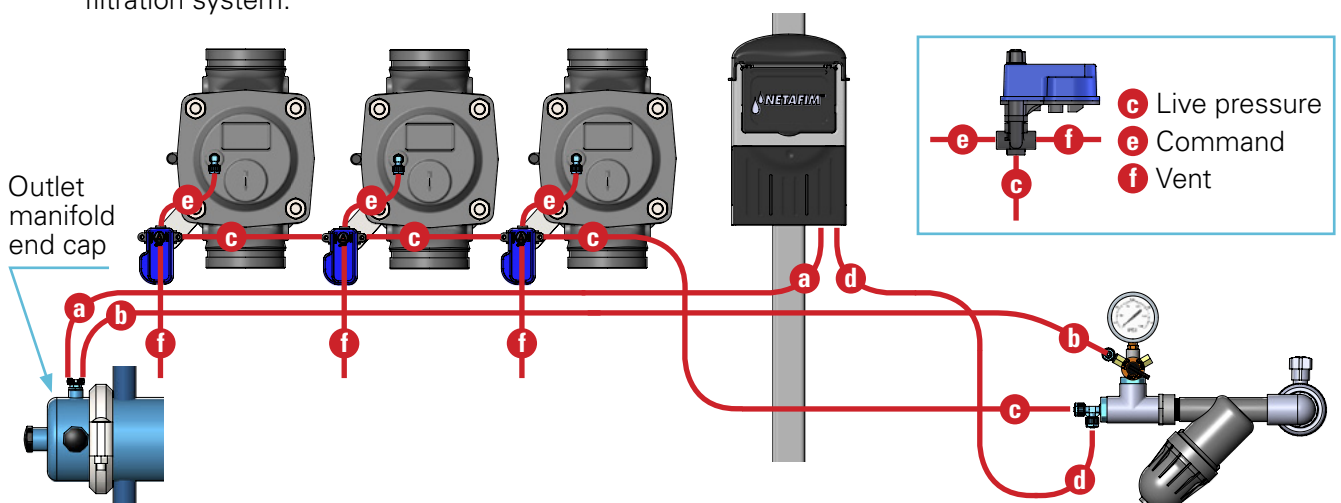

INSTALLATION

20. Connect the solenoids to the BackFlush controller expansion cards ordered in sequence, from left to right. Red wire = + / black wire = common (inversing wire polarity will change NC to NO).



ATTENTION

The solenoids must be of the 12v DC latching type.

- a. Connect 2 solenoids to each expansion card.
- b. If there is an odd number of filters in the system, connect the last one as illustrated.



NOTE

If each solenoid is placed on its respective backwash valve, secure the cables with plastic zip ties in an organized and tidy fashion along the filtration system.

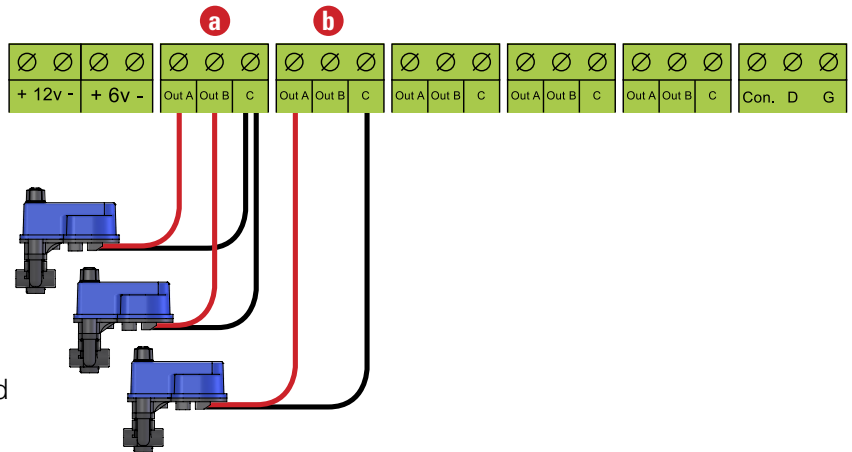

(For full instructions, see the BackFlush controller manual).



NOTE

If the filtration system was not ordered with a BackFlush controller and is intended to be connected to an existing irrigation system controller, see the irrigation controller user manual for instructions.

21. Connect the BackFlush controller to the electricity source:

A. For controllers powered by an external 12v DC power supply



WARNING

When operating the controller with the external power supply, make sure there are no batteries in the battery tray.

- Connect the external 100-240v AC to 12v DC power supply to the BackFlush controller 12v DC input.
Red wire = + / black wire = -.

- Connect the power supply to a water-resistant socket.

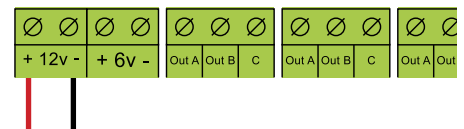

B. For controllers powered by 4 x 1.5v D-size alkaline batteries (6v DC)

- Connect the battery tray to the BackFlush controller 6v DC input.
- Insert the batteries.
Match the poles to the markings inside the battery tray.

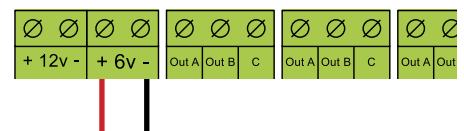

(For full instructions, see the BackFlush controller manual).



NOTE

If the filtration system was not ordered with a BackFlush controller and is intended to be connected to an existing irrigation system controller, see the irrigation controller user manual for instructions.

INSTALLATION

22. Close all the openings of the manifold end caps with the 2" plugs supplied with the control kit.
23. Connect the filtration system inlet and outlet to the main irrigation line with flanges (see the [NOTE](#) under step 10, page 13).
24. Connect the backwash pipe to the flange of the backwash manifold (see the [NOTE](#) under step 10, page 13).
25. Visually check (with the aid of a flashlight) the inside of all the tanks, through the filling port, for damaged, missing or unsecured under-drain diffusers ("flutes"). Replace, re-fit, re-connect and re-secure if necessary.



ATTENTION

Before filling the tanks with media

Fill each tank with water up to a third of its height with a hose through the filling port before media filling to prevent damage to the under-drain diffusers when pouring the media.

26. Fill the tanks with media through the filling port.
Fill each tank up to the media level marker on the filter tank.

Tank diameter (inch)	Sand quantity*	
	kg	lbs
30	270	595
36	350	772
48	675	1488

*Crushed basalt.

27. Flatten the surface of the media.
28. Make sure that the filling port and its gasket are clear of any remaining gravel particles and close the filling port.

Install add-ons (optional)

- It is recommended to install a secondary (screen) filter on the main line, downstream from the media filtration system.
- It is recommended to install a manual isolation valve downstream from the media filtration system for maintenance purposes.

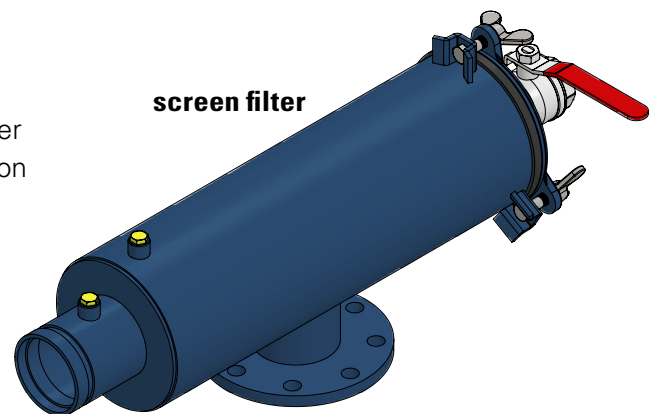

INITIAL OPERATION

1. Set the BackFlush controller

The controller is equipped with an LCD display and 4 keys, as displayed below. When the unit is left untouched for a minute, the display switches off and a beep is heard every 20 seconds to indicate it is working.

Holding down any of the keys for a few seconds will bring the screen back to life.

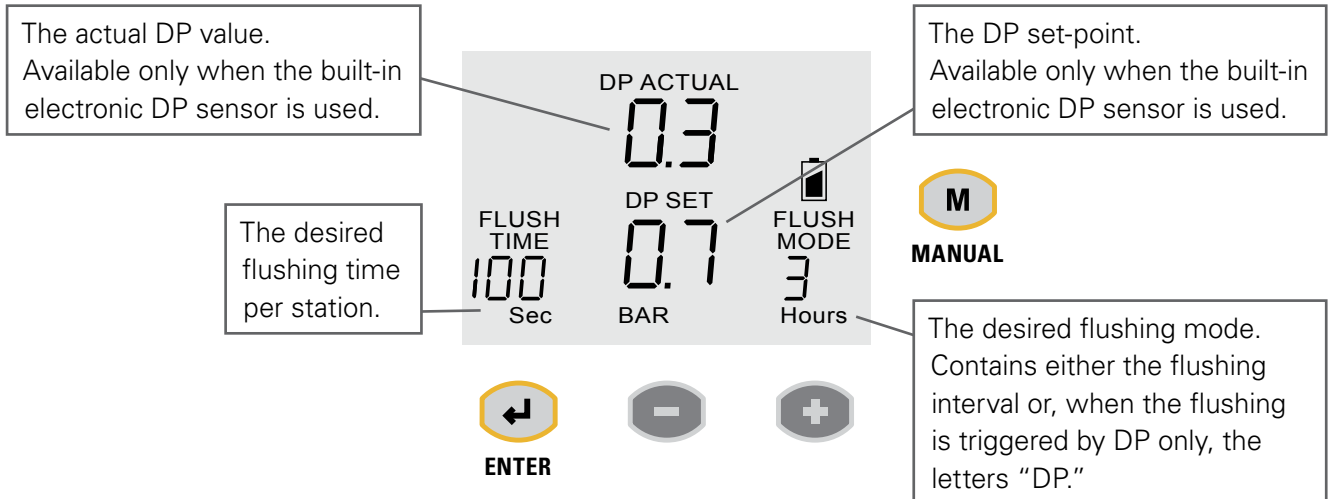

The screen consists of several fields. Some of them are editable and some of them are not.

To enter the EDIT MODE, press the key. The EDIT MODE is indicated by blinking of the currently editable field.

Each time you press the key, the next editable field becomes active and starts blinking.

Use the and keys to change the value in the active field.

Press the key again to set the selected value for the current field and move to the next editable field.

To return to a previous field during the process of passing through the editable fields, press the key repeatedly until you get back to the FLUSH TIME field, and there are blinking fields. You can then begin the process again.





Configuration

Parameter	Definition	Action
Main valve (sustaining valve)	The pre-dwell delay between the main valve opening and the opening of station 1	Select: YES if exists Enter: 20 sec
Dwell time	The backwashing delay between stations	Enter: 10 sec
DP delay	The delay during which the DP sensor reading is expected to remain stable before reaction	Enter: 10 sec
Looping limit	The number of consecutive flushing cycles triggered by the DP sensor before deciding that there is an endless looping problem	Enter: 3
Alarm	Allocates one output for alarm activation	Select: YES
Delay valve	Allocates one output for delay-valve activation	Select: YES if exists

(continued on the next page)

INITIAL OPERATION

Configuration (continued)



Parameter	Definition	Action
View outputs	This is a special mode that enables the user to review the list of outputs and their allocations. The output number is displayed in the bottom left corner and its allocated function appears in large letters in the center of the screen	Use the  key to toggle between NO and YES and confirm by pressing the  key. Keep using the  key to review the list
Pressure units	Select the units to be used for pressure measurement	Select: BAR or PSI
Calibration	Zero calibration of the built-in electronic DP sensor.	Disconnect the sensor ports from the command tube and open them to atmospheric pressure; then select calibration: YES
Version display	Displays the controller's software version-number.	No action required. Press the  key twice to proceed.
Flush time	The desired flushing time per station.	Enter: 100 sec
DP set-point	The pressure difference between the filter's inlet and outlet that initiates a flushing cycle.	Enter: 0.7 bar or 10 PSI
Flush mode	The flushing interval or, when the flushing is triggered by DP only, the letters "DP."	Enter: 3 hours

(For full instructions, see the BackFlush controller manual).



NOTE

If the filtration system was not ordered with a BackFlush controller and is used with an existing irrigation system controller, see your irrigation controller user manual for instructions.

2. Turn on the water and start irrigation.
3. As soon as the system is pressurized and stable. Start a manual backwashing cycle by pressing the  key. The icon  will appear on the display (to manually terminate a backwashing cycle in progress, press the same key).
4. After completion of a full backwashing cycle, check that the filtration system DP is within the operational range (0.15-0.4 bar/2.2-5.8 PSI, depending on the flow rate). Toggle the control kit 3-way ball valve and note the filtration system inlet and outlet pressure. Subtract the outlet pressure from the inlet pressure. The result is the filtration system DP.
5. Check all the filtration system connections for water leaks – re-fit, re-connect and re-secure if necessary.
6. Check all the command tube connections for leaks – re-fit, re-connect, and re-secure if necessary.
7. Check that the backwashing cycle is performed in the correct order and that all the filters in the system are backwashed in sequence.
8. Check the secondary filter (if installed) for the presence of gravel.



NOTE

If a secondary filter is not installed, disconnect the main line pipe downstream from the filtration system, let the water flow to the ground and visually check for the presence of gravel.

If gravel is present, see [Troubleshooting](#), page 22.



ATTENTION

Steps **2** to **8** above should be performed whenever the operation of the filtration system is resumed after being idle (i.e., after seasonal shutdown, maintenance or troubleshooting operations).

TROUBLESHOOTING



WARNING

Do not perform maintenance operations or open filter ports before the pressure in the system is fully released. For draining purposes, open any valve downstream from the filtration system until the pressure is fully released. Check the pressure gauge to be sure it is at 0 before proceeding. Alternatively, you can open the valve installed on the outlet manifold end-cap - if installed (see [TIP](#), page 3).

If the flushing cycle does not start but the controller is initiating the flushing signal and the solenoids are reacting (“clicking”):

1. Check the command filter in the control assembly. Clean it if necessary and perform manual flushing.
2. Check for clogging inside the solenoid valves - clean if possible or replace with a new solenoid.
3. Check for clogging of the hydraulic control tubes - open the clogs and clean if necessary.
4. Check for a ruptured or defective hydraulic control tube - replace if necessary.

If the media is running out through the outlet manifold during filtration:

1. Depressurize the system.
2. Disconnect the outlet manifold and visually identify which filter tank is losing gravel.
Alternatively, you can open the filling ports of the tanks, one by one, and visually identify the tank in which the media level has dropped.



ATTENTION

There may be more than one tank losing gravel.

3. Empty the media from the tank/s and replace the damaged under-drain diffuser/s (“flutes”) inside the tank/s.
4. Refill the tank with media (see instructions in the Installation chapter, [steps 24-26](#), page 19).

If the media is running out through the backwash manifold during backwash:

1. Adjust the backwash flow-control valve on the backwash manifold.
 - If a manual backwash flow-control valve is installed, throttle the valve to reduce the flow until the media stops running out.
 - If a hydraulic backwash flow-control valve is installed, the valve is factory pre-set to the required flow rate.

In the rare case that the backwash flow-control valve requires fine-tuning:

- a. Release the pilot lock-nut.
 - b. Gently rotate the pilot calibration bolt counterclockwise with a wrench to reduce the flow until the media stops running out.
 - c. Retighten the pilot lock-nut.
2. Check the level of media inside the filters.
 - If the level is lower than the media level marker on the filter tank - add media.
 - If the level is higher than the media level marker on the filter tank - remove media.

WARRANTY

Netafim™ warrants all the components of the SandStorm™/SandStorm™ NC media filter system to be free of defects in material and workmanship for 5 (five) years from the date of installation.

If a defect is discovered during the applicable warranty period, Netafim™ will repair or replace, at its discretion, the product or the defective part.

This warranty does not extend to repairs, adjustments or replacements of a Netafim™ media filter system or part that results from misuse, negligence, alteration, force majeure, lightning, power surge, improper installation or improper maintenance.

If a defect arises in your Netafim™ product during the warranty period, contact your local Netafim™ representative.

Limited warranty

This warranty is subject to the conditions in Netafim's official warranty statement.

(For the full text of Netafim's official warranty statement, please contact your local Netafim™ representative).

GROW MORE WITH LESS

WWW.NETAFIM.COM